

ILLUSTRATED CATALOGUE.

M. MYERS & SON,

HARLOTTE STREET STEEL PEN WORKS,

BRITAIN

PATENTERS AND MANUFACTURERS

OF

STEEL PENS, PENHOLDERS

REMNANTS & CASES;

LETTER CLIPS, ELASTIC

PAPER BINDERS

AND

STATIONERS

JOHN GATLEY, ENGRAVER

M. MYERS & SON'S PATENT METALLIC PENS.











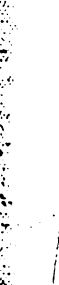

Selection of useful Patterns for General Purposes.

No.	Material	Illustration	Description	Quality	Price
3106	Bronze		School Pen, Plain	Good Quality	6d.
			Shoulder Pen, Plain	Best Quality	8d.
3099	Bronze		Shoulder Pen, Plain	Good Quality	7d.
3051	Bronze		Shoulder Office Pen, Strong	Best Quality	8d.
431	Bronze		Commercial J Pen	Best Quality	1/-
			Selected G Pen	Best Quality	8d.
			Tique Pen	Best Quality	9d.
			Pen	Best Quality	9d.
			Pen	Best Quality	9d.
			Pen	Best Quality	9d.





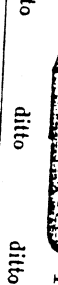
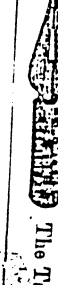

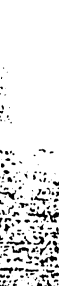



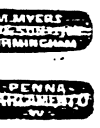
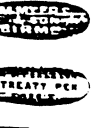
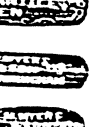

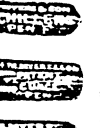
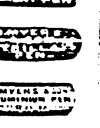
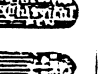



irmingham.

STEEL PENS.—Continued.

Selection of useful Patterns for General Purposes.

158		Counting House Pen	1 1/2
159		The Celebrated American Falcon Pen. This is acknowledged to be the best general purpose Pen in the market, and has a very large sale	1 1/2
160		The Seven Star Pen	9/16
161		The Classical Pen	9/16
162		Curved Point Pen	9/16
163		Mountain Pen	9/16
164		Mountain Spear Pen	1 1/4
165		Alexandre Von Humboldt Cement Pen	1 1/4
166		School Pen	9/16
167		Patent Galvanized Giant Pen	9/16
168		Patent Galvanized Shell-fish Pen	9/16
169		Patent Galvanized Shoulder Pen	9/16
170		First-Class Pen	1 1/4
171		The Jerusalem Pen	1 1/4
172		The Palmyra Pen	9/16
173		Prince of Wales Pen	9/16

Charlotte Street, Steel Pen Works, Birmingham.

3056		Penna Pen	3088		Treaty Pen	161		Treaty Pen	3011		Treaty Pen	2028		Treaty Pen	1020		Treaty Pen	3186		Treaty Pen	2036		Treaty Pen	68		Treaty Pen	3171		Treaty Pen	3030		Treaty Pen	2089		Treaty Pen	062		Treaty Pen	222		Treaty Pen
3110		Regulator Pen	431		Regulator Pen	3018		Regulator Pen	2080		Regulator Pen	3202		Regulator Pen	3203		Regulator Pen	3173		Regulator Pen	3170		Regulator Pen	2079		Regulator Pen	41		Regulator Pen	8		Regulator Pen	1010		Regulator Pen	5060		Regulator Pen	202		Regulator Pen
27 N		Blind Pen	041758		Blind Pen	27		Blind Pen	20035		Blind Pen	2068		Blind Pen	0027		Blind Pen																								

STEEL PENS.—Continued.

SELECTION OF USEFUL PATTERNS FOR GENERAL PURPOSES.

FOR ILLUSTRATIONS, SEE PAGE 41

1/11	10d.	1/2	1/2	10d.	10d.	10d.	9d.
3056	3189	5088	5089	104	3011	2028	1020
White	Bronze	Bronze	Tinted	Bronze	Bronze	Tinted	Tinted
9d.	11d.	2/-	11d.	10d.	10d.	9d.	8d.
3186	20368	68	3171	3030	2089	0628	222
Grey	White		Grey	Grey	White	Grey	Grey
11d.	8d.	8d.	9d.	11d.	9d.	1/-	1/-
3110	431	432	14/18	3018	2080	3202	3203
Grey	Bronze	Bronze	Bronze	Grey	Bronze	Grey	Grey
1/14	8d.	10d.	8d.	8d.	7 1/2d.	8d.	9d.
3173	3170	2079	44	8	1010	5060	2029
Bronze	Bronze	Grey	Bronze	Tinted	Bronze	Tinted	White
1/4	8d.	8d.	8d.	8d.	8d.	3/4	6d.
171	3086	031A	031B	031C	031D	5062	0128
Grey	Tinted	1/2	1/2	1/2	1/2		
2/8	2/1	2/8	2/4	2/-	1/4	1/4	1/4
03062	03031	031	02010	0112	03043	0112	05081
Gilt	Gilt	D.G.	Gilt	Gilt	Gilt Pt.	Gilt Pt.	Gilt Pt.

MAGNUM BONUM PENS.

(FOR ILLUSTRATIONS, SEE PAGE 41)

2/8	3/-	3/4	4/-	1/4	2/-	3/-	per Gross.
027N	027N	04475S	3085	2068	27	0027	in Boxes of 1 dozen, with Holder.
			1/6				2035 in Boxes of 3 dozen, with Holder.

All Pens may be had in E.P., F., M., or B Points.

PATENT SKELETON PEN.

Quill Holders, with Metallic Points. In boxes of 2 dozen Pens, with Holder to each Box (12 Boxes on Card) ... 48/- per Gross Boxes

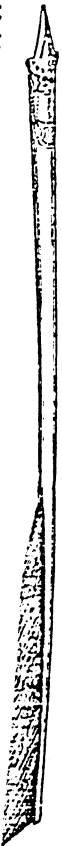

Extract from "ILLUSTRATED LONDON NEWS."

"Improved Steel Pens.—One of the most general objections to the use of Steel Pens is their extreme fragility, a defect which has been effectually prevented in the 'Skeleton' or Metallic Points for Quill Pens, patented by M. Myers & Son, in which the ease and comfort of the Quill is combined with the durability of the Steel Pen."

Charlotte Street Steel Pen Works, Birmingham.

FANCY BOXES OF STEEL PENS.

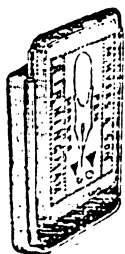

217



1873

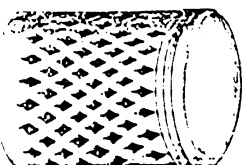

1883

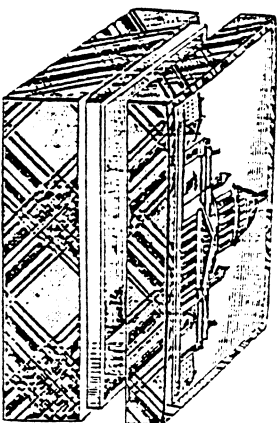

1870

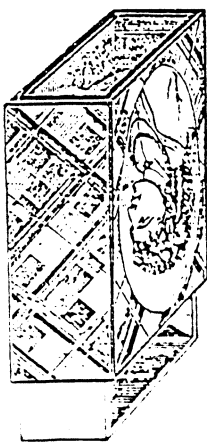

1881

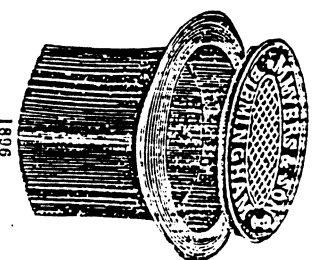

1896

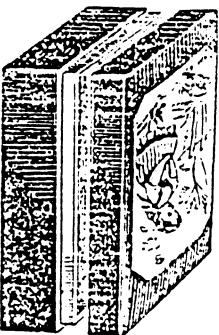

1882

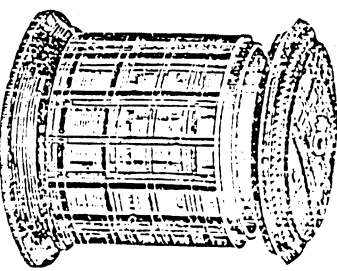

1877

- 1876 Round Ornamented Yin Box, containing 1 dozen Pens, 3 dozen Boxes on Card
- 1874 Flat Brass Box, containing 1 dozen Pens, 3 dozen boxes on Card
- 244 Flat Box, Gold or Silver color, Sliding Lid, with 1 dozen Pens, in Cartoons of 1 gross
- 217 Superior Quality Flat Box, Gold color, Sliding Lid, containing 1 dozen Pens, on Cards of 2 dozen
- 1873 Flat Ornamented Yin Box, Sliding Lid, containing 3 dozen Pens, assorted patterns, 12 Boxes on Card
- 1875 Tartan Wood Box, round, containing 1 dozen Gilt Pens, in Cartoons of 1 dozen
- 1877 Tartan Wood Box, round, containing 1 gross good Steel Pens
- 1879 Tartan Wood Box, round, with Brush, containing 1 gross good Steel Pens

Charlotte Street Steel Pen Works, Birmingham.

FANCY BOXES OF STEEL PENS—Continued.

1	Italian Wood Box, square, containing 1 gross Pens	20/-
2	Italian Wood Box, square, to slide, with colored Picture, containing 100 Pens	16/-
3	Black Enamelled Wood Box, with colored Picture, containing 3 dozen Pens	8/-
4	Enamelled Metal Box, Nickel-plated, containing 1 gross Pens	8/-
5	Prince of Wales Pen, 2 dozen in Slide Box, with Photograph, 1 dozen Boxes in case	4/-
6	Prince Imperial Pen, 2 dozen in Slide Box, with Photograph, 1 dozen Boxes in case	4/-
7	Celebrated J Pen, 11 dozen in Slide Box, 1 dozen Boxes on Card	24/-
8	Selected G Pen, 11 dozen in Slide Box, 1 dozen Boxes on Card	24/-
9	Shoulder Pen, 11 dozen in Slide Box, 1 dozen Boxes on Card	24/-
10	Celebrated J Pen, 3 dozen in Slide Box, 12 Boxes in Case	48/-
11	Selected G Pen	48/-
12	Shoulder Pen	48/-
13	Seven Star Pen	48/-
14	Celebrated American Falcon Pen, 3 dozen in Slide Box, 12 Boxes in Case	48/-
15	Golden Mountain Pen, 2 dozen in Slide Box, 12 Boxes in Case	48/-
16	Bullion Pen, 1 dozen in Slide Box, 1 dozen Boxes in Case	48/-
17	Metal Box—Hat Sharp, containing 1 gross Pens. "A Hat full of Pens for 1/-"	96/-

(FOR ILLUSTRATIONS, SEE PAGE 61)

MAPPING BARREL PENS.



62A	Mapping Pens, 3 dozen in Box, with 3 Holders	3/4
62B	Ditto	3/4
62C	Ditto	4/-
62D	Ditto	5/4
62E	Ditto	6/-
62F	Ditto	6/-
62G	Ditto	7/4
62H	Ditto	8/-

Charlotte Street Steel Pen Works, Birmingham.

M. MYERS & SON'S PATENT & OTHER PENHOLDERS

No. 152 Sliding Holder

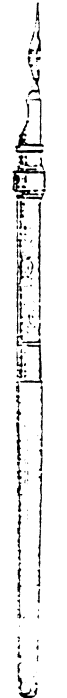

No. 766 Ejecting Holder

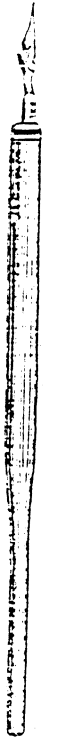

No. 109 Ejecting Holder



No. 135



No. 653

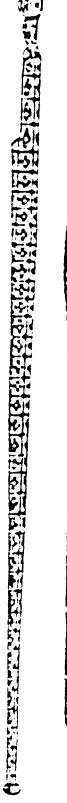

No. 621



No. 2021P



No. 210



All Penholders measured Full Length, including Tip.

No.	Description	Per Gross	Per Doz
754	5 1/2 in. Accommodation School Penholder, coloured fluted handle, good tip	1/2	1/2
16	ditto	1/4	1/4
17	6 in. ditto	1/2	1/2
18	6 in. ditto	1/2	1/2
4	6 in. ditto	1/2	1/2
4D	6 1/2 in. ditto	1/2	1/2
735	9 in. Coloured Paper Holder, good tip	1/2	1/2
4T	ditto	1/2	1/2
547	9 in. ditto	1/2	1/2
274	5 1/2 in. Imitation Gashier Handle, steel split tip	1/2	1/2
550	6 in. ditto	1/2	1/2
533	6 in. ditto	1/2	1/2
138	6 in. ditto	1/2	1/2
313	7 in. ditto	1/2	1/2
199	6 1/2 in. ditto	1/2	1/2
534	6 in. Imitation Ebony Twisted Handle, strong steel binding tip with stop	1/2	1/2
525	7 in. Ditto	1/2	1/2
530	9 in. Ditto	1/2	1/2

PENHOLDERS—Continued.

No.	Penholder Description	Per Oz.	Per Doz.
5639	9-in. Imitation Feather Taper Twisted strong steel binding tip with stop	3/1	37/1
285	6-in. Real Cedar Holder smooth, steel split tip	2/1	24/1
291	6-in. Ditto binding steel tip, galvanized, with stop	2/8	28/8
544	6 1/2-in. Polish Wood Holder, swelled centre, strong binding steel tip	4/-	48/-
652	7-in. Ditto thick, swelled centre, strong steel spring tip	6/8	81/8
157	6 1/2-in. Real Cedar Fluted Holder, steel spring tip	3/1	37/1
228	6-in. Ditto Taper Fluted Holder, binding steel tip	3/-	36/-
311	7-in. Ditto Taper Holder, steel split tip	3/1	37/1
315	9-in. Ditto ditto	4/-	48/-
136	6-in. Ditto Twisted Holder, gilt tip	6/-	72/-
225	7-in. Ditto Taper Holder, binding steel stop tip	3/9	40/9
227	7-in. Ditto Taper Twisted Holder, steel spring tip	4/1	49/1
260	9-in. Ditto Taper Thin Holder, binding steel tip with stop	4/1	49/1
265	9-in. Ditto Taper Twisted Holder, ditto	4/8	48/8
526	9-in. Ditto Taper Fluted Holder, steel spring tip	5/-	60/-
226	7-in. Ditto Taper Twisted Holder, thick strong steel tip	6/8	81/8
327	7-in. Ditto Taper Twisted Holder, thick strong steel tip	6/8	81/8
319	6 1/2-in. Ditto Anti-Blocking Holder, French Pattern	16/-	192/-
135	6 1/2-in. Ditto ditto, superior quality, swelled centre, gilt tip	8/-	96/-
136A	6 1/2-in. Ditto ditto, on cards, with gilt pen	12/-	144/-
2610	7-in. Enamelled Holder, assorted colors, brass tip with stop	16/-	192/-
2610J	7-in. Ditto ditto, gilt tip	8/-	96/-
591	7-in. Black Enamelled Holder, silver spring tip, gilt pen	10/3	124/3
592	7-in. Ditto ditto, gilt tip	13/1	157/1
621	7 1/2-in. Ditto fancy silvered tip and gilt pen	16/-	192/-
622	7-in. Ditto ditto	16/-	192/-
281	7-in. Rosewood Taper Holder, galvanized steel stop tip	6/8	81/8
239J	6 1/2-in. Ditto brass stop tip	7/4	88/4
171	6 1/2-in. Ditto gilt steel spring tip	12/-	144/-
300	7-in. Ditto thick, strong steel spring tip	13/1	157/1
287	7-in. Ditto superior gilt steel spring tip and gilt pen	24/-	288/-
170	6-in. Scotch Mind Holder, brass accommodation tip	5/4	65/4
419	9-in. Scotch Plain Taper Holder, brass tip with stop	9/4	113/4
165	6 1/2-in. Scotch Turtan Holder, brass tip with stop	6/8	81/8
207	6 1/2-in. Ditto gilt steel tip	9/4	113/4
452	6 1/2-in. Ditto gilt spring tip	13/1	157/1
230	7 1/2-in. Ditto taper, brass tip with stop	10/8	124/8
166	9-in. Ditto taper, brass tip with stop	12/-	144/-
151	6 1/2-in. Ditto taper, gilt patent spring tip	24/-	288/-
559	8-in. Ditto taper, swelled, gilt binding tip and gilt pen	32/-	384/-
202	8-in. Ditto taper, swelled, gilt binding tip with stop, gilt pen	32/-	384/-
202J	8-in. Ditto taper, with photograph	42/8	504/8
417	8-in. Whitewood Swelled Taper Holder, very thick, strong gilt spring tip and pen	48/-	576/-
416	8-in. Scotch Turtan Holder, with views, gilt binding tip and pen	48/-	576/-
210	8-in. Ditto with photograph	13/4	160/4
322	8-in. Whitewood ditto	13/4	160/4
769	6 1/2-in. Floral Holder, gilt binding stop tip with gilt pen	8/-	96/-
770	6 1/2-in. Ditto brass tip	8/-	96/-
128	6 1/2-in. Fancy Pattern Paper Holder, brass tip, very pretty	6/4	76/4
213J	4 1/2-in. Bone Taper, plain, galvanized steel tip and pen	8/8	104/8
214	5-in. Ditto plain, brass tip	8/-	96/-
699	5-in. Ditto plain, steel strong tip	8/-	96/-
276	5-in. Ditto fancy, brass tip with stop	10/-	120/-
216	5 1/2-in. Ditto plain, brass tip with stop	13/4	160/4

Charlotte Street Steel Pen Works, Birmingham

PENHOLDERS—Continued.

No.	Penholder Description	Per Oz.	Per Doz.
208	5 1/2-in. Bone Taper, plain, gilt steel tip and pen	16/-	192/-
275	6-in. Ditto swelled, brass tip and pen	17/1	204/1
267	6-in. Ditto fancy, brass tip and pen	15/-	180/-
447	6-in. Ditto fancy, gilt spring tip and pen	22/8	273/8
351	6 1/2-in. Ditto fancy, gilt spring tip and pen	20/-	240/-
398	6-in. Ditto swelled, gilt spring tip and pen	20/-	240/-
253	7 1/2-in. Ditto fancy, brass stop tip and pen	27/8	324/8
400	8-in. Ditto balance, gilt spring tip and pen	33/1	396/1
654	5 1/2-in. Ditto plain, fancy gilt star tip and gilt pen	16/-	192/-
655	6 1/2-in. Ditto plain, fancy silver star tip and gilt pen	18/-	216/-
613	6 1/2-in. Ditto fancy, gilt star tip and gilt pen	22/8	273/8
656	8 1/2-in. Ditto fancy, silver star tip and gilt pen	26/8	312/8
657	8 1/2-in. Ditto gilt star tip and gilt pen	26/8	312/8
750	5-in. Ditto plain, nickel-plated tip, engine-turned, and gilt pen	24/-	288/-
746	5 1/2-in. Ditto plain, nickel-plated tip, engine-turned, and gilt pen	24/-	288/-
751	6-in. Ditto swelled, nickel-plated tip, engine-turned, and gilt pen	32/-	384/-
752	6-in. Ditto plain, nickel-plated tip, engraved, and gilt pen	32/-	384/-
753	6 1/2-in. Ditto plain, nickel-plated tip, engraved, and gilt pen	39/-	468/-
748	7 1/2-in. Ditto plain, nickel-plated tip, engraved, and gilt pen	39/-	468/-
744	7 1/2-in. Ditto swelled, nickel-plated tip, engraved, and gilt pen	39/-	468/-
102	6-in. Ditto plain, long gilt metal tip, engraved, gilt pen	40/-	480/-
103	6 1/2-in. Ditto ditto	39/-	468/-
104	7-in. Ditto ditto	37/1	444/1
105	7-in. Ditto ditto	42/8	504/8
280	7 1/2-in. Ditto plain, ditto	40/-	480/-
779	7 1/2-in. Ditto swelled, ditto	41/-	492/-
106	7-in. Ditto fancy, ditto	36/-	432/-
162	6-in. Ditto plain, with engraved german silver tip, to slide	18/-	216/-

PENHOLDERS, with Ejecting Tips.

1313	7-in. Black Enamelled Holder, nickel-plated engraved ejecting tip, gilt pen	32/-	384/-
766	6-in. Polish Wood Holder, plated ejecting tip and pen	24/-	288/-
767	4 1/2-in. Bone Taper ditto	32/-	384/-
768	6-in. Ditto ditto	40/-	480/-
108	6-in. Ditto ditto	32/-	384/-
109	6 1/2-in. Ditto long gilt ejecting tip, gilt pen	36/-	432/-
111	6 1/2-in. Ditto ditto	40/-	480/-
112	6 1/2-in. Ditto swelled, ditto	44/8	528/8
110	6 1/2-in. Ditto ditto	36/-	432/-
107	7-in. Ditto ditto	37/1	444/1
113	7 1/2-in. Ditto ditto	48/-	576/-
114	7 1/2-in. Ditto swelled ditto	48/-	576/-

PORCUPINE QUILL PENHOLDERS.

639	7 1/2 to 9-in. Porcupine Quill Holder, gilt steel tip and pen	16/-	192/-
610	8 1/2 to 10-in. Ditto	24/-	288/-
627	9 to 10-in. Ditto long gilt steel tip and pen	32/-	384/-
628	10 to 12-in. Ditto long fancy metal tip, silvered and gilt pen	48/-	576/-
629	10 to 12-in. Ditto fine large quills	48/-	576/-
302	10 to 12-in. Ditto gilt tip, fine large quills	48/-	576/-
		18/-	216/-

Charlotte Street Steel Pen Works, Birmingham.

METAL PENHOLDERS.

Decorated Tin Reversible Holder	Per Doz. 3/-	Per Doz. 4/-
Ditto	3/8	4/1
Ditto with rubber and measure	6/-	7/-
Ditto with pen and pencil	5/1	6/8
Nickel-plated Penholder, assorted patterns, gilt pen. A very nice present		4/8
G.S. Telescope, reversible, for the pocket		3/2
Ditto engraved		4/0

SUPERIOR PRESENTATION PENHOLDERS, with Sterling Silver Tips.

4 1/2-in. Pearl Handle, engraved silver tip	Per Doz. 17/-
5-in. Ditto engine-turned silver tip	21/-
5 1/2-in. Ditto hexagon, engraved silver tip	22/8
5 1/2-in. Ditto round, engraved silver tip	25/8
6 1/2-in. Ditto very fine, round, engraved silver tip	38/8
5 1/2-in. Ivory round, engraved silver tip	16/-
6-in. Ditto round, engine-turned silver tip	19/4
6 1/2-in. Ditto large hexagon, engraved silver tip	24/-
6 1/2-in. Ditto large fluted, silver tip	95/8
4 1/2-in. Agate round, engraved with mount on top	25/8
7 1/2-in. Ditto assorted colors, round, engraved tip	40/-
7 1/2-in. Foreigne Quill, round, engraved silver tip and top mount	9/4
7 1/2-in. Ditto round, engraved silver tip and top mount	11/4
8-in. Ditto hexagon, engraved silver tip and top mount	14/8
8-in. Ditto round, engraved silver tip and top mount	14/-
9-in. Ditto hexagon, engraved, silver tip and top mount	18/-
9 1/2-in. Ditto round, engine-turned	19/-

PENHOLDERS, ASSORTED (On Cards).

4 1/2-in. White Bone Holder, taper, with galvanized steel tip and pen	Per Doz. 8/-
5-in. Ditto black steel tip and pen	8/-
Assorted Tartan, Wood, and Fancy Paper Holders, with brass tips and pens	6/8
Ditto Wood Holders, swelled centres, steel tips and pens	6/-
Ditto Fancy Holders, with brass tips and good pens	7/1
Ditto Tartan, Cedar, Bone, and Fancy Wood Holders, brass tips and pens	8/-
Ditto Tartan, Cedar, Bone, and Fancy Wood Holders, brass tips and pens	8/-
Ditto Ebony, Rosewood, and Bone Holders, with best gilt tips and pens	16/-
Ditto Black Enameled Holders, with gilt and silvered tips and pens	16/-
5-in. Bone Holders, swelled centres, with gilt and silvered tips and pens	16/-
5-in. Bone Taper, silvered star tips and gilt pens	16/-
Assorted Bone and Porcupine Holders, with gilt tips and pens	16/-
6 1/2-in. Bone Holders, assorted plain and fancy, with gilt and silvered tips and pens	24/-
7-in. Bone Tapers, fancy gilt tips and pens	32/-
7 1/2-in. Bone Tapers, with fine engraved gilt tips and pens	48/-

Charlotte Street Steel Pen Works, Birmingham.

ALUMINIUM GOLD PENCILS.

(For Description, &c., see Pages 14 & 15.)

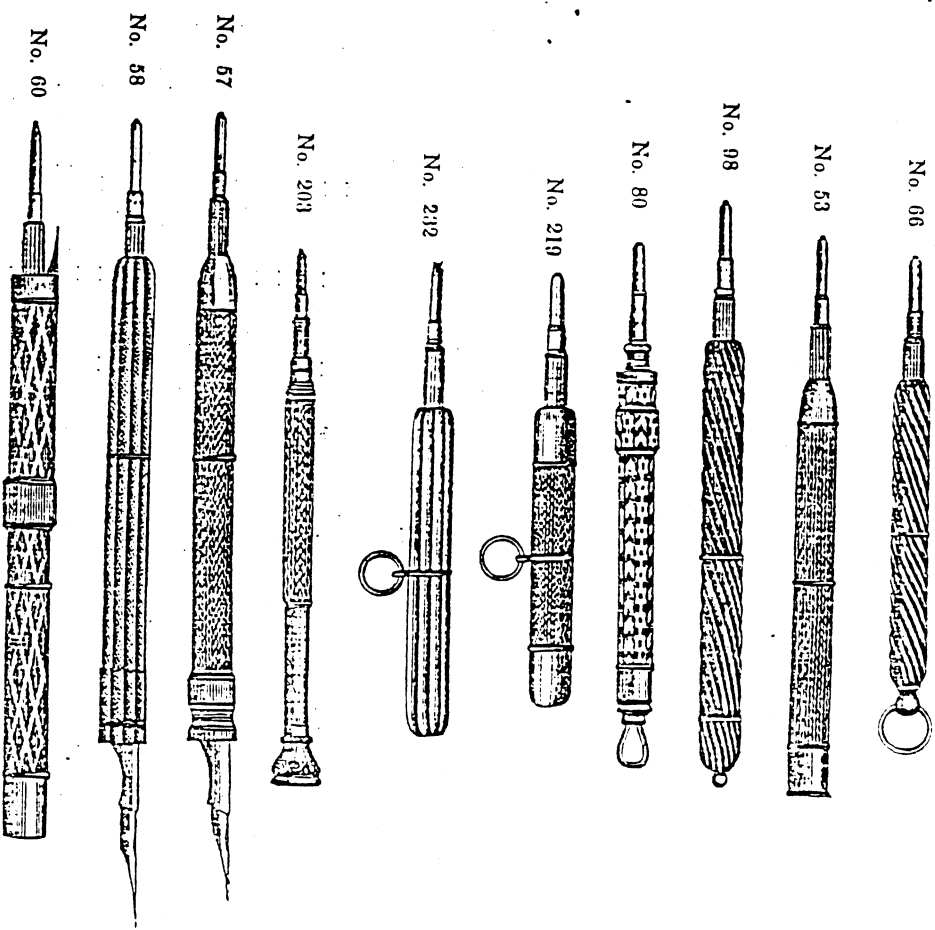

Charlotte Street Steel Pen Works, Birmingham.

ALUMINIUM GOLD PENCILS.

(For Description, &c., see Pages 14 & 15.)

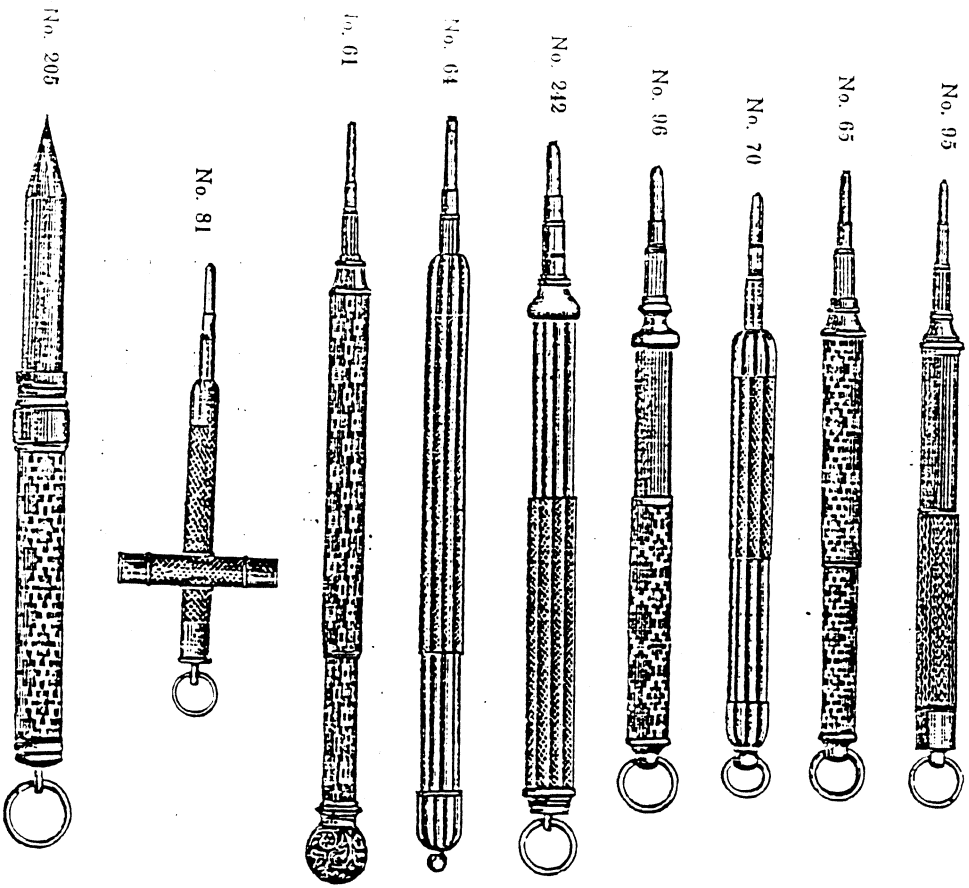

Charlotte Street Steel Pen Works, Birmingham.

ALUMINIUM GOLD PENCILS.

Manufactured of the finest Aluminium Gold, sustaining a high finish, very strong and durable, and presenting a rich appearance.

(FOR ILLUSTRATIONS, SEE PAGES 12 & 13.)

No. 69	Spiral, engine-turned	10/8
No. 84	Ditto	12/7
No. 235	Ditto	no reserve	13/1
No. 86	Ditto	with reserve	11/1
No. 236	Ditto	with reserve	14/1
No. 63	Ditto	ditto	14/8
No. 65	Ditto	ditto	16/7
No. 62	Ditto	ditto	15/7
No. 51	Ditto	thin long	20/7
No. 62	Ditto	goldie	16/7
No. 68	Spiral, twisted	ditto	16/7
No. 98	Ditto cable pattern	ditto	15/8
No. 227	Ditto black enamelled	ditto	14/7
No. 90	Ditto engine-turned	with ring	14/7
No. 66	Ditto twisted	ditto	13/1
No. 67	Ditto ditto	ditto	16/7
No. 97	Ditto cable pattern	ditto	larger	..	16/7
No. 61	Ditto engine-turned	ditto	small	..	13/2
No. 234	Ditto ditto	ditto	small	..	16/7
No. 77	Ditto black enamelled	ditto	small	..	16/7
No. 237	Ditto ditto	ditto	large	..	16/7
No. 83	Ditto engine turned, with swivel	and reserve	19/8
No. 66	Pull-out ditto	with ring, small	15/7
No. 94	Ditto black enamelled, and reserve	15/7
No. 223	Ditto	16/7
No. 203	Ditto engine - turned	ditto	17/1
No. 214	Match Chain Bar Penol,	ditto	16/7
No. 219	Ditto	ditto	16/7
No. 220	Ditto	damask	16/7
No. 233	Ditto	engine-turned	16/7
No. 232	Ditto	goldie	16/7
No. 241	Ditto	ornamental	21/4
No. 215	Ditto	damask, magio extension	32/7
No. 216	Ditto	engine-turned	32/7
No. 217	Ditto	plain	32/7
No. 226	Ditto	black enamelled, ditto	32/7
No. 248	Ditto	engine-turned ditto with ball ends	30/7
No. 258	Ditto	elongating, engine-turned	18/7
No. 259	Ditto	18/7
No. 60	Small Charm Penol, engine-turned, spiral	18/7
No. 243	Double-motion, engine-turned, no reserve	20/7
No. 62	Ditto	engine-turned, with reserve	33/1
No. 63	Ditto	ditto	32/7
No. 64	Ditto	goldie	32/7
No. 213	Ditto	engine-turned, with ball top	33/4

Charlotte Street Steel Pen Works, Birmingham.

ALUMINIUM GOLD PENCILS—Continued.

	Per Doz.	
61	Double-action, damask, engine-turned, with reserve, ball top	36/-
62	Ditto black enamelled, ditto	33/4
63	Ditto damask, with ring	32/-
64	Ditto engine-turned ditto	32/-
65	Ditto plain ditto	32/-
66	Ditto black enamelled ditto	32/-
67	Ditto black enamelled ditto	32/-
68	Ditto engine-turned, with ball top and ring	31/-
69	Ditto gothic, with ring	36/-
70	Ditto silver aluminium mount, with ring	33/-
71	Ditto pearl, with ring	36/-
72	Ditto pearl, with ring	36/-
73	Ditto pearl, with ring	36/-
74	Ditto from the front, engine-turned, with ring	70/-
75	Ditto ditto damask	75/-
76	Ditto ditto gothic	33/4
77	Ditto ditto engine-turned	33/4
78	Ditto ditto ditto reserve	28/-
79	Ditto engine-turned, with swivel	32/-
80	Ditto Slide Pencil, with band and reserve	36/-
81	Ditto Ditto with band and swivel	16/-
82	Ditto Ditto Case, damask, with ring; cedar pencil	16/-
83	Ditto Spiral and elongating, engine-turned	16/-
84	Ditto Spiral Pencil, and Slide Penholder at other end	18/8
85	Ditto ditto ditto	24/-
86	Ditto ditto ditto	30/-
87	Ditto ditto ditto	27/-
88	Ditto ditto ditto	40/-
89	Ditto ditto ditto	32/-
90	Ditto ditto ditto	53/4
91	Ditto ditto ditto	48/-
92	Ditto ditto ditto	44/-
93	Ditto ditto ditto	54/-
94	Ditto ditto ditto	54/-
95	Ditto ditto ditto	30/-
96	Ditto ditto ditto	20/-
97	Ditto ditto ditto	30/-
98	Ditto ditto ditto	11/8
99	Ditto ditto ditto	10/8

Charlotte Street Steel Pen Works, Birmingham.

STERLING SILVER PENCILS.

No. 102



No. 106



No. 109



No. 110

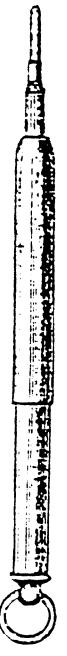

No. 107



No. 100



No. 112



No.	Description	Per Doz.
100	Spiral, with reserve, engine-turned	20/-
101	Ditto " " gothic pattern	21/-
102	Ditto " " lady's, thin	16/-
103	Ditto with ring, engraved, small charm	16/-
104	Ditto " " telescopic	18/-
105	Sliding Pencil, with ring, engine-turned	18/-
106	Double-action Spiral, with ring, engine-turned	36/-
107	Ditto " " plain	36/-
108	Ditto " " with reserve, engine-turned	38/-
109	Ditto " " large diameter	40/-
110	Ditto " " with handsome chased seal head	51/-
111	Ditto " " Pen, Pen and Knife, engine-turned	36/-
112	Ditto " " The "Alonster" Double Spiral Pen and Pencil, both working by a double spiral action at the same end	51/-
113	The "Champion" Pencil, telescopic magic, engine-turned, with ring, length open, 5 1/2-in.; closed, 2 1/2-in.	60/-
114	The "Army" Pencil, telescopic magic, with ring, very massive, length open, 7 1/2-in.; closed, 3 1/2-in.; diameter, 1-in.	27/-

Charlotte Street Steel Pen Works, Birmingham.

THE AMERICAN
COMPOUND SPIRAL PEN AND PENCIL CASE.

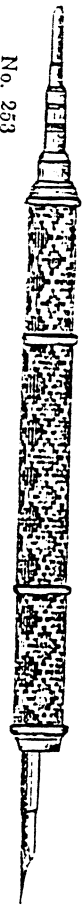

No. 253
The strongest and most serviceable Pencil Case ever introduced into the market.
It is made with Pen at one end and Pencil at the other, both with
Spiral Action.

No.	Description	Per Doz.
252	Aluminium Gold, plain	40/-
253	Ditto engine-turned or damasked	40/-
254	Sterling Silver	54/-

TOOTHPICKS.

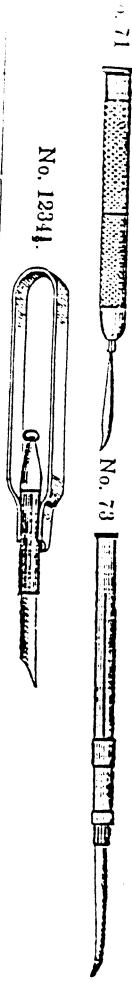

No.	Description	Per Doz.
89	Aluminium Gold, spiral and gold pick	16/-
201	Ditto spiral and tortoiseshell pick	10/8
76	Ivory in ivory case, with screw	14/-
714	Aluminium to slide and tortoiseshell pick	8/-
73	Nickel-plated, to slide and tortoiseshell pick	4/-
718	Silver spiral and plated pick	4/-
719	Gilt " " " "	4/-
1234	French Quill Toothpick, in nickel-spring holder	2/8
76	Tortoiseshell " " " "	4/-

BONE AND AGATE STYLES.

No.	Description	Per Doz.
1	Bone Point, mounted in Ebony Holder	40/-
2	" " " "	48/-
6	" " Bone " "	48/-
4	" " and Penholder, in German-silver shut-up case	80/-
4	" " Penholder and Pencil " "	90/-
7	" " in strong engine-turned silver-plated case, with seal	144/-
8	" " in nickel-plated case, to slide	48/-

Charlotte Street Steel Pen Works, Birmingham.

POCKET PENCILS,
PROPELLING AND WITHDRAWING.

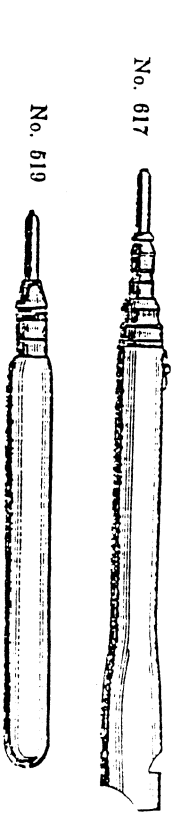
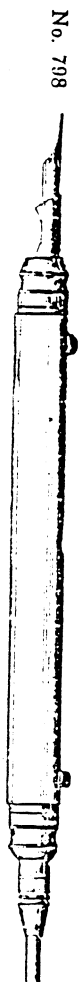

No.	Description	Per Doz.
607	4-in. Handsomely-ornamented Pen, Pencil and Knife, two Blades	45/-
687	" " " " " "	40/-
609	" " " " " "	32/8
1B	3 1/2-in. " " " "	34/3
1B	Bent " " " "	34/9
613	Flat " " " "	29/4
231	Plain " " " "	25/5
230	Plain " " " "	32/5
608	Ornamented, Pencil and one Penknife Blade	16/-
603	" " and one " " " "	12/-
254	Plain " " " "	17/4
756	" " and one Pen and Pencil " "	8/3
758	Ditto Sliding Pencil " "	6/3
759	Ditto " " " "	6/3

IVORY PENNOL CASES.

Charlotte Street Steel Pen Works, Birmingham.

BONE PENCILS.

	Per Doz.
Pen, Pencil and Knife	10/-
Ditto " " superior quality	12/-
Sliding Pencil and Knife	6/8
Ditto " fixed point	4/4
Pen and Pencil, to slide on both ends	8/-
Ditto " "	4/6
Ditto " " at same end	7/1
Ditto " " with lead reserve	7/1
Ditto " " with ball top	7/4
Ditto " reversible	3/4
Pen, Pencil and Knife, reversible	6/8
Pen and Pencil, reversible, with screw lead reserve to each	4/-
Sliding-point Pencil, black or white, with ring	4/-
Ditto " large	4/-
Ditto " smaller, with lead reserve	3/4
Ditto " with ball top	3/4
Ditto " plain	3/4
Ditto " with whistle	6/8
Ditto " with microscope	8/-
3 1/2-in. Fixed-point Pencil	2/-
3-in. " " with ring	2/-
3 1/2-in. " " with ring	2/8
4 1/2-in. " " Pocket-book Pencil, with nickelized ball top	3/8

COCOA PENCILS.

Pen, Pencil and Knife	10/8
Sliding Pencil and Knife	6/8
Pencil and Penholder, to slide at both ends	8/-
Ditto " " at same end, with lead reserve	7/4
Pencil only, to slide	4/-

TARTAN WOOD PENCILS.

Pen, Pencil and Knife	12/-
Sliding Pencil and Knife	6/8
" " Pencil and Penholder	7/4
" " reversible	4/-
Sliding Pencil, with ring, small	4/-
Spiral Tablet Pencil, with ivory top	2/-

Charlotte Street Steel Pen Works, Birmingham.

METAL PENCILS.

No. 786
 No. 626
 No. 804
 No. 673
 No. 671
 No. 746
 No. 650
 No. 662

PURE NICKELISED AND METAL COMBINATION POCKET PENCILS

No.	ON HANDSOME CARDS OF A-DOZEN.	Per Doz.
787	Classopot Movement, with reserve, ball top, half plain, half engraved, hexagon	8/-
647	Ditto " " seal top, gilt	8/-
626	Ditto " " silver-plated	8/-
702	Ditto " " ball top, damask, nickel and gilt	8/-
715	Ditto " " engraved	8/-
788	Ditto " " home body	8/-
779	Spiral " "	8/-
719	Sliding " " with band, hexagon	8/-
724	Spiral " " telescopic, engraved	8/-
600	Ditto " " silver-plated	8/-

Charlotte Street Steel Pen Works, Birmingham.

METAL PENCILS—Continued.

1	Spiral Movement, telescopic, plain	8/-
2	Ditto " " engraved, with ring	8/-
3	Ditto " " key	8/-
4	Ditto " " watch chain bar	8/-
5	Ditto " " plain, with reserve	8/-
6	Ditto " " engraved	8/-
7	Ditto " " engine-turned	8/-
8	Ditto " " damask, gilt, and nickel, with reserve	8/-
9	Ditto " " black enamelled	8/-
10	Ditto " " with ring	8/-
11	Ditto " " aluminium, with swivel	8/-
12	(Hingespot " " engine-turned " " small	8/-
13	Ditto " " plain	8/-
14	Ditto " " black damask, with ball end, reserve	8/-
15	Algeria Extension, engine-turned	12/-
16	Ditto " " plain, with ring, small	12/-
17	Ditto " " black enamelled, with ring, small	16/-
18	Spiral Movement, plain, with ring	16/-
19	Ditto " " engraved, with reserve	6/-
20	Ditto " " plain	4/-
21	Ditto " " fixed point, with ring	4/-
22	Ditto " " black enamelled, fixed point, with ring	2/8
23	Ditto " " fluted pocket-book pencil, with reserve	4/-
24	Ditto " " fixed point, with microscope	2/8
25	Slicing " " with band, hexagon, engraving, small, with ring	4/-
26	(Hingespot " " plain, with reserve	4/-
27	Spiral " " with eraser	4/-
28	" " elongating, German-silver, engraved	4/-
29	" " " " " " with ring	8/-

SUPERIOR METAL PEN AND PENCILS.

1	Pen and Pencil, to slide, both ends, nickel-plated damask	8/-
2	Ditto " " silver-plated	4/6
3	Ditto " " engine-turned	4/-
4	Ditto " " at same end, damask	8/-
5	Ditto " " spiral, with sliding penholder, silver-plated	8/-
6	Ditto " " reversible, damask, with seal top	8/-
7	Ditto " " German silver, damask, telescopic	4/4
8	Ditto " " " " plain, telescopic	4/4
9	Ditto " " " " engraved	4/-
10	Ditto " " nickel-plated	4/-
11	The Posting Pencil, long taper penholder and pencil, nickel-plated	4/-
12	The Stock Exchange Pencil, strong nickel-plated case, with ring and best cedar pencil	4/-
13	Pen and Pencil, reversible, nickel-plated	2/8
14	Ditto " " plain, with rubber	2/6
15	Ditto " " " " " "	2/4
16	Ditto " " Case, reversible, with cedar pencil and India-rubber	17/4
		32/-

Charlotte Street Steel Pen Works, Birmingham.

ASSORTED POCKET PENCILS, on Illuminated Show Cards.

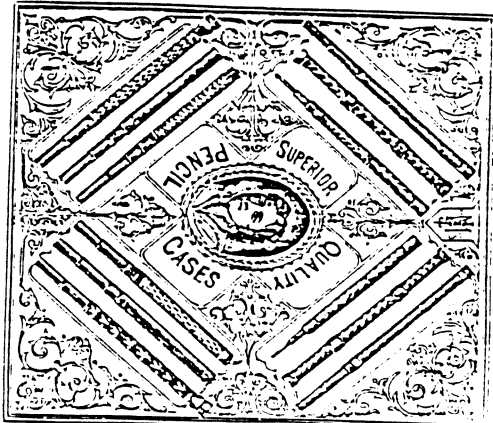

No.	Description	Per Doz.
409	One dozen well assorted nickel, black, damask, and gilt Pencils	9/6
301	Ditto " " Bone Pencils	4/8
401	Ditto " " " " " "	9/6
501	Ditto " " " " " " Yarnan Wood Pencils	4/8
303	Ditto " " " " " " German Silver Pencils	4/8

ASSORTED POCKET PENCILS, in Counter Cases.

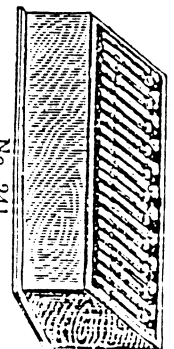
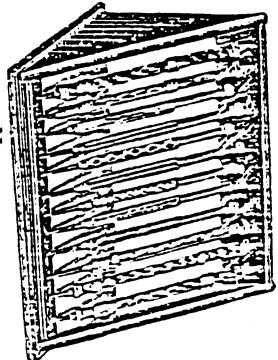

No.	Description	Per Doz.
223	Superior Black-polished wood Case, with locking glass back, containing 1-doz. best finished nickel-plated Pencil Cases, assorted patterns	17/1
241	Superior polished wood Case, containing 2-doz Metal Pencil Cases	8/8
245	Ditto " " " " " " containing 2-doz. Bone Pencil Cases, assorted patterns	8/8
232	Ditto " " " " " " containing 1-doz. Aluminium Gold Pencils, assort. patterns	17/1

Charlotte Street Steel Pen Works, Birmingham.

ERASERS AND DESK KNIVES.

ERASERS.



No.	Description	Per Doz.
59	3 1/2-inch Flat Ebony Handle	4/8
60	3 1/2-inch " Cocoon	4/6
61	3 1/2-inch " Bone	5/1
62	4-inch " " "	7/1
63	4-inch " " "	6/-
64	4-inch " " "	6/-
65	4-inch " " "	6/-
66	4-inch " " "	6/-
67	4-inch " " "	6/-
68	4-inch " " "	6/8
69	4-inch " " "	9/4
70	5-inch " " "	9/-
71	5-inch " " "	9/1
72	Small Patent Erasers	10/-
		Per Doz.

DESK KNIVES, with Straight Blades.



No.	Description	Per Doz.
71	4-inch Flat Cocoon Handle	5/-
72	4-inch Round Scotch Wood Handle	8/8
73	4-inch " and Curved Buffalo Handle	7/9
74	4 1/2-inch Tapered Bone	10/-
75	4 1/2-inch " " "	10/-
76	4 1/2-inch " " "	8/-
77	5-inch Flat Scotch Wood	10/-

DESK KNIVES, with Spear-Headed Blades.



No.	Description	Per Doz.
72	3 1/2-inch Flat Bone Handle	5/9
73	3 1/2-inch " " "	6/8
74	4 1/2-inch " " "	8/-
75	4 1/2-inch " " "	10/-

Charlotte Street Steel Pen Works, Birmingham.

DESK KNIVES—Continued.

No.	Description	Per Doz.
128	4 1/2-inch Flat Ebony Handle	7/2
68	4 1/2-inch " Scotch Wood Handle	10/6
69	5-inch " " "	8/8
66	4 1/2-inch Flat Cocoon Wood Handle	7/1
67	4 1/2-inch " Bone	5/9
113	4-in. Square Ebony Handle, German-silver mount	9/6
127	4-in. " " " " " " "	11/1
72	4-in. Round and Curved Buffalo Handle, large German-silver mount	8/8
77	4 1/2-inch Tapered Ebony Handle	11/1
85	4 1/2-inch " " "	8/8
73	4 1/2-inch " " "	8/8
55	4 1/2-inch " " "	11/1

All Erasers and Desk Knives on Cards of 1-Dozen.

M. MYERS & SON'S POCKET KNIVES, BEST SHEFFIELD MAKE.



(For Description, &c., see Page 25.)

Charlotte Street Steel Pen Works, Birmingham.

P. SETT KNIVES, Best Sheffield Make.
 (FOR ILLUSTRATIONS, SEE PAGE 24)

ON CARDS OF 1DOZEN.

No.	Material	Description	Per Doz.
721	Ivory	one blade	5/1
722	Buffalo	"	5/8
703	Carved Horn	two blades	9/8
705	Buck Horn	two "	9/8
708	Ditto	"	9/8
717	Ivory	small, two "	9/8
713	Ditto	large, two "	9/8
714	Buffalo	two "	10/-
716	Ivory	two "	10/-
725	Pearl	small, German-silver mounted, two blades	10/-
726	Ivory	German-silver mounted, with shield, two blades	11/4
727	Ditto	long, plain, two blades	11/8
723	Ditto	small G.S. mounted, with shield, two blades	11/8
728	Ditto	with shield, two blades	12/-
707	Buffalo	G.S. mounted, two blades	12/-
711	Ivory	"	12/8
706	Buck Horn	with shield	12/8
715	Ivory	"	14/8
710	Pearl	small, G.S. mounted, with shield, two blades	15/-
720	Tortoiseshell	small, " " two "	15/-
719	Pearl	small " " two "	15/-
729	Ditto	" " two blades	16/-
730	Ditto	" " two blades	16/-
700	Buffalo	large, G.S. mounted, two blades	16/8
731	Ivory	" with shield, two blades	16/8
704	Buck Horn	extra long, with shield, two blades	16/8
735	Ivory	" " two "	16/8
733	Ditto	G.S. mounted, with shield, three "	16/8
702	Ditto	with shield, extra long, three "	18/8
734	Buck Horn	with shield, extra long, two "	18/8
736	Ivory	with shield, four blades	20/-
709	Buck Horn	G.S. mounted, with shield, three blades	20/-
741	Ivory	" " three "	21/8
732	Pearl	" " three "	21/8
737	Ditto	small " " two blades	22/4
710	Ivory	with shield " " three "	22/4
712	Ditto	" " three "	24/4
713	Ditto	" " three "	24/8
714	Tortoiseshell	G.S. mounted, with shield, three blades	25/4
708	Pearl	large " " three "	30/8
715	Ditto	round large " " three "	32/4
716	Buck Horn	G.S. mounted, with shield, two blades and cork screw	32/4
717	Ditto	long, with shield, three blades	37/1
621	Scottish Tartan Wood	small, one blade	72/-
1	Ditto	" " one "	4/-
020	Ditto	" " one "	7/4
15	Ditto	fruit knife, one blade	8/-
14	Ditto	" " larger, one blade	7/8
5	Ditto	two blades	9/4
6B	Ditto	two "	12/-
8B	Ditto	large, two blades	12/-
25	Ditto	" two "	12/8
32	Ditto	small, three "	12/8
013	Ditto	large, three "	16/-
33	Ditto	small, four "	16/8

Charlotte Street Steel Pen Works, Birmingham.

POCKET MICROSCOPES



083

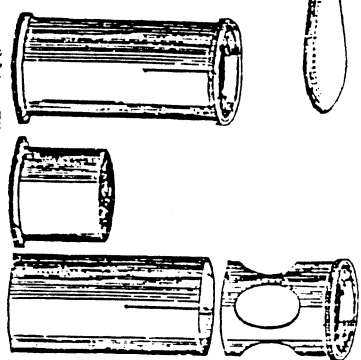

084.—The Elton Microscope.

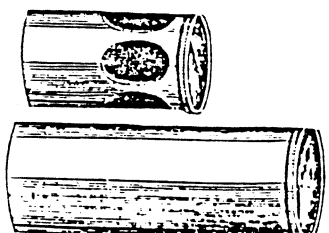

087.

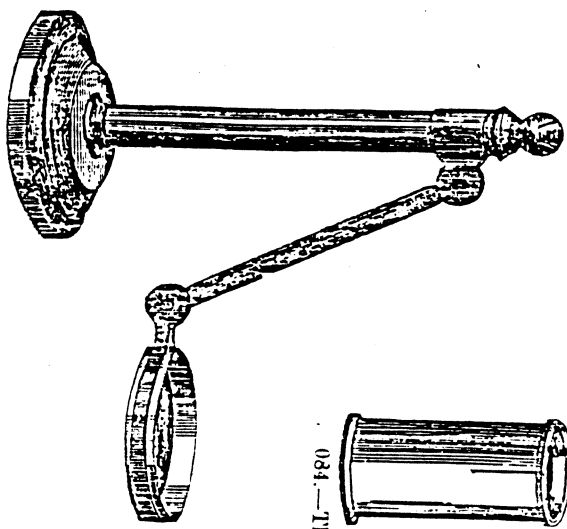

085

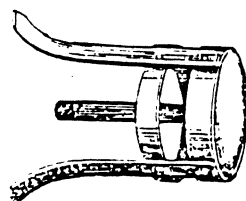

091

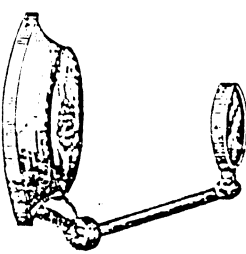

060

067.—For examining Flowers, Photographs, &c.

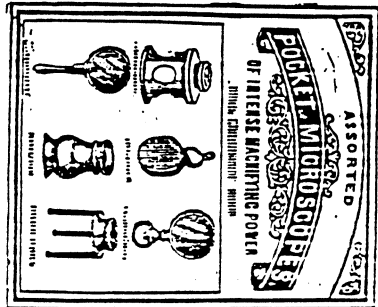

216.—Assorted Card

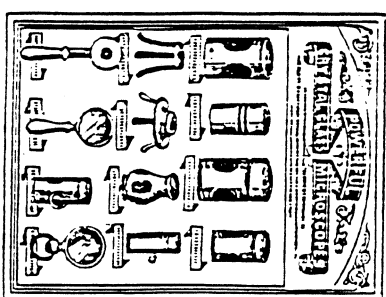

207.—Assorted Card.

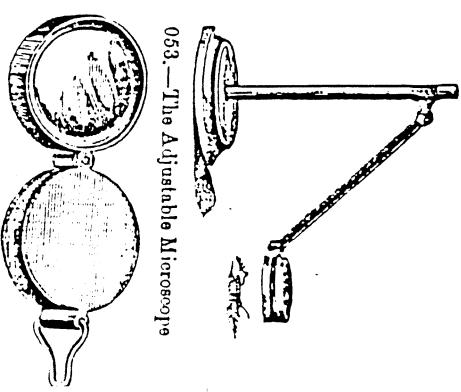

053.—The Adjustable Microscope

073

MICROSCOPES—Continued.

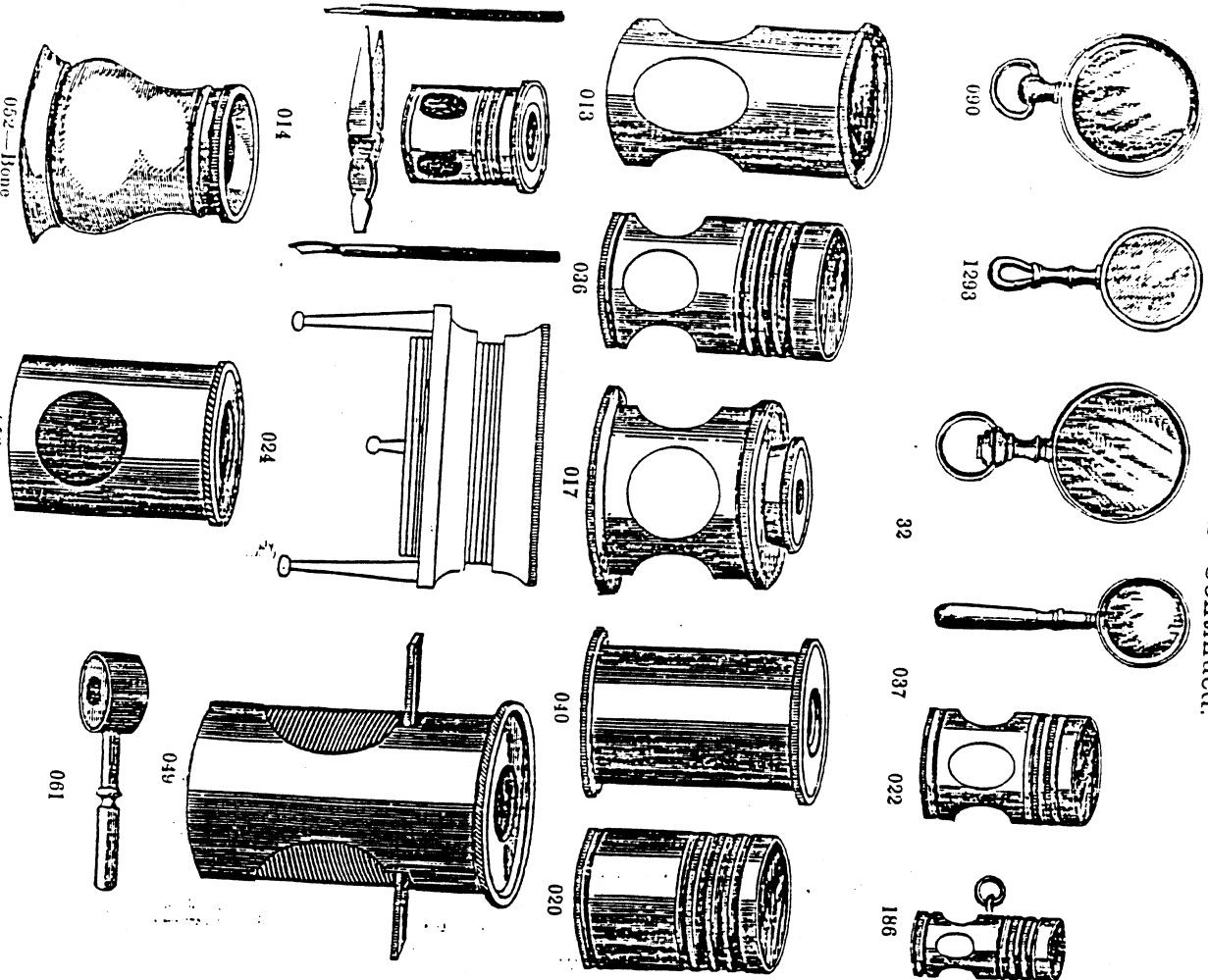

MICROSCOPES—Continued.

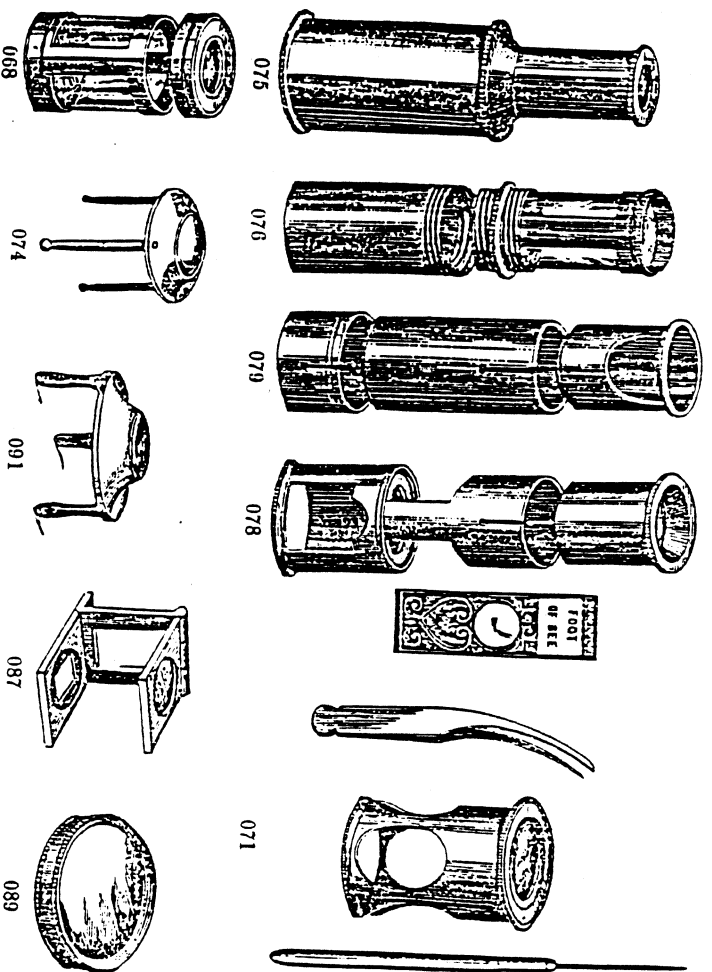

POCKET MICROSCOPES.

HIGH MAGNIFYING POWER.

Carded or Boxed in Dozens. For Illustrations, see Pages 26, 27 & 28.

No.	Description	Per Doz.
186	Small Darrel Microscope, with ring	48/-
082	" Ditto " hook canopy, with ring	48/-
32	Pocket Microscope, with ring, nickel-plated, very powerful lens	96/-
35	The "Jarringtons" Microscope	48/-
013	Pocket Microscope, long tube	96/-
014	" with dissecting instruments	96/-
071	" Ditto " nickel-plated, with dissecting instruments	96/-
024	Botanic Tripod, 1 1/2-in. with screw movement	16/-
016	" Ditto " 1 1/2-in.	26/8
086	" Ditto " 1 1/2-in.	36/-

Charlotte Street Steel Pen Works, Birmingham.

MICROSCOPHS—Continued.

Carded or Boxed in Dozens. For Illustrations, see Pages 26, 27 & 28

117	Hussyan Microscope	96/-
118	Pocket Microscope, double lens, very powerful	144/-
119	Ditto	48/-
120	Ditto	48/-
121	Ditto	black enamel	48/-
122	Ditto	long tube	48/-
123	Ditto	new registered pattern, assorted black and bone handles	96/-
124	Ditto	on cards of two dozen	48/-
125	Colorado Microscope, on cards of half-dozen	24/-
126	Pocket Microscope, with object chamber	96/-
127	Cloth and Linen Pryer	96/-
128	Ditto	96/-
129	Table Microscope, tripod	96/-
130	Pocket " "	large tube, with object glass to each	96/-
131	The "Favourite" Pocket Microscope	96/-
132	Opera Microscope, small	96/-
133	Ditto	large	48/-
134	The "Adjustable" Microscope, separately boxed	48/-
135	"Stanley"	96/-
136	"Adjustable"	48/-
137	"Carte-de-Visite and Pryer" Magnifier	24/-
138	" "	36/-
139	" "	48/-
140	"Cabinet" Microscope, separately boxed	48/-
141	"Stanhope"	96/-
142	"Beaumont"	96/-
143	"Faraday"	96/-
144	"Seed"	48/-
145	" "	96/-
146	" "	48/-
147	" "Tynal"	96/-
148	" "Table"	96/-
149	" "Criterion" Opera Glass; very powerful	96/-
150	" "Compound" Microscope, with object glass to each	48/-
151	" "Leopold"	96/-
152	" "Lieberkuhn"	96/-
153	" "Jkon"	48/-
154	Linen Pryer, to close up	144/-
155	Ditto	144/-
156	Round Burning Glass	96/-
157	Ditto	96/-
158	Table Microscope	96/-
159	Assorted Card Pocket Microscopes, one dozen on card	96/-
160	Ditto	48/-
161	" "	48/-
162	" "	96/-

Charlotte Street Steel Pen Works, Birmingham.

EXCELSIOR READING GLASSES

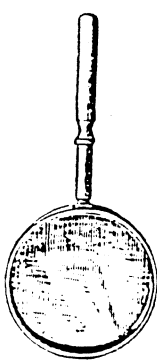

No.	Diop.	1 1/2	2	2 1/2	3	3 1/2	4	4 1/2	5	5 1/2	6
3	Brass Frames, Bone Handles, per doz.	4/-	8/-	12/-	16/-	21/-	28/-	36/-	45/-	54/-	63/-
4	Nickel " "	4/-	8/-	12/-	16/-	21/-	28/-	36/-	45/-	54/-	63/-
5	Brass " Black " "	4/-	8/-	12/-	16/-	21/-	28/-	36/-	45/-	54/-	63/-
6	Nickel " " "	4/-	8/-	12/-	16/-	21/-	28/-	36/-	45/-	54/-	63/-

READING GLASSES, Assorted, on Cards.

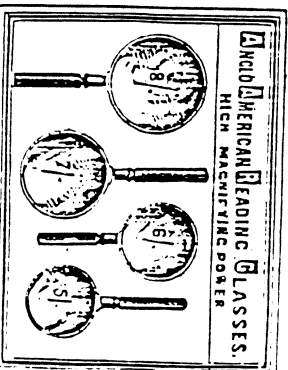
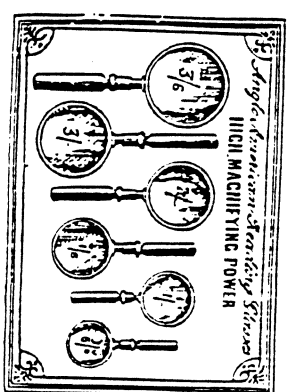

No.	Diop.	1 1/2	2	2 1/2	3	3 1/2	4	4 1/2	5	5 1/2	6
205	Containing one each	11.	2.	2 1/2.	2 3/4.	3.	3 1/2.	4.	4 1/2.	5.	5 1/2.
206	Ditto	11.	2.	2 1/2.	2 3/4.	3.	3 1/2.	4.	4 1/2.	5.	5 1/2.
215	Ditto	"	"	3 1/2.	3 3/4.	4.	4 1/2.	5.	5 1/2.	6.	6 1/2.

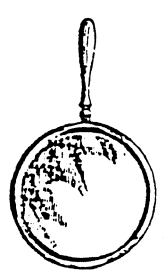

No.	Description	Per Doz.
1358	Pocket Reading Glass, nickel-plated frame, with ring	96/-
072	Ditto	18/-

Charlotte Street Steel Pen Works, Birmingham.

READING GLASSES—Continued.
 RACK OF TWELVE READING GLASSES

Handsome Mahogany Rack
 Containing 12 Reading Glasses, viz.:—two each 1½, 2-in., one each
 2½, 2¾, 3, 3½, 3¾, 4-in. Diameter.

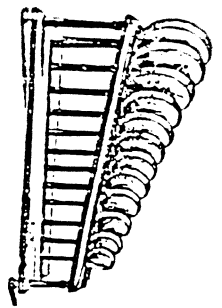

No. 3. Brass Frames, Bone Handles 31/9	No. 4. Nickel Frames, Bone Handles 31/9	No. 5. Brass Frames, Black Handles 30/6	No. 6. Nickel Frames, Black Handles 30/6
---	--	--	---

RACK OF SIX READING GLASSES
 Handsome Mahogany Rack.

Containing 6 Reading Glasses, viz.:—one each 2½, 3, 3½,
 3¾, 4-in. Diameter.

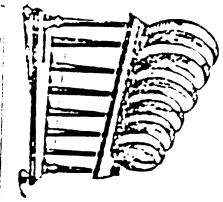

No. 3A. Brass Frames, Bone Handles 26/6	No. 4A. Nickel Frames, Bone Handles 26/6	No. 5A. Brass Frames, Black Handles 24/-	No. 6A. Nickel Frames, Black Handles 24/-
--	---	---	--

THE NEW REGISTERED READING GLASSES

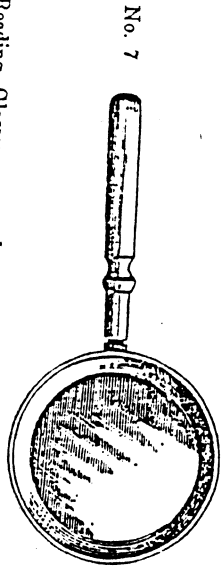
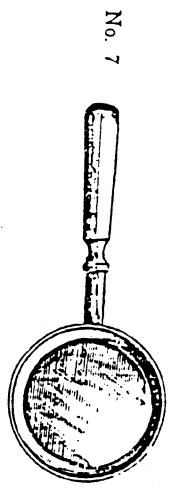

These Reading Glasses are made upon an entirely new and improved principle, the metal rim which holds the lens, being made of solid tube, there is no danger of any part coming un-soldered; they are also much stronger, and have a better appearance than the old kind.

7	Brass Frames, Bone Handles, per doz.	1½	2	2½	2¾	3	3½	3¾	4 in.
8	Nickel " "	4/-	8/-	12/-	16/-	24/-	28/-	32/-	
9	Brass " "	4/-	8/-	12/-	16/-	24/-	28/-	32/-	
10	Nickel " "	4/-	8/-	12/-	16/-	24/-	28/-	32/-	

Not made larger.
 With Bone Handles,
 53/4 64/-
 59/4 64/-

M. MYERS & SON'S
 PATENT ELASTIC BANDS

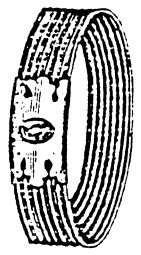

For Purses, Pocket Books, Letters, &c., &c., these Bands, which are to be had in all sizes, will prove of great use. The Elastic is fastened by a Spring Slip, which can be unfastened and a new elastic inserted.

No.	Width	Price per gross	Material
15	4-in.	8/-	Silk
"	5-in.	8/8	"
"	6-in.	9/4	"
"	4-in.	14/6	"
"	5-in.	15/3	"
"	6-in.	16/-	"
7	Medium	24/-	"
"	Tweed	30/-	"
10	1-in.	24/-	"

PATENT STAMP DAMPER.

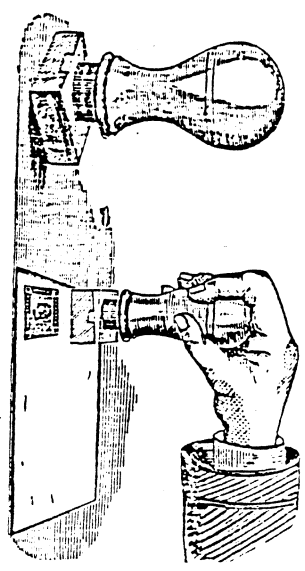

A very useful article for Damping Postage Stamps, Envelopes, and other adhesive papers.

Carded, 1-dozen on Card, with directions for use 8/-

Charlotte Street Steel Pen Works, Birmingham.

PATENT LETTER CLIPS.

M. MYERS & SON'S

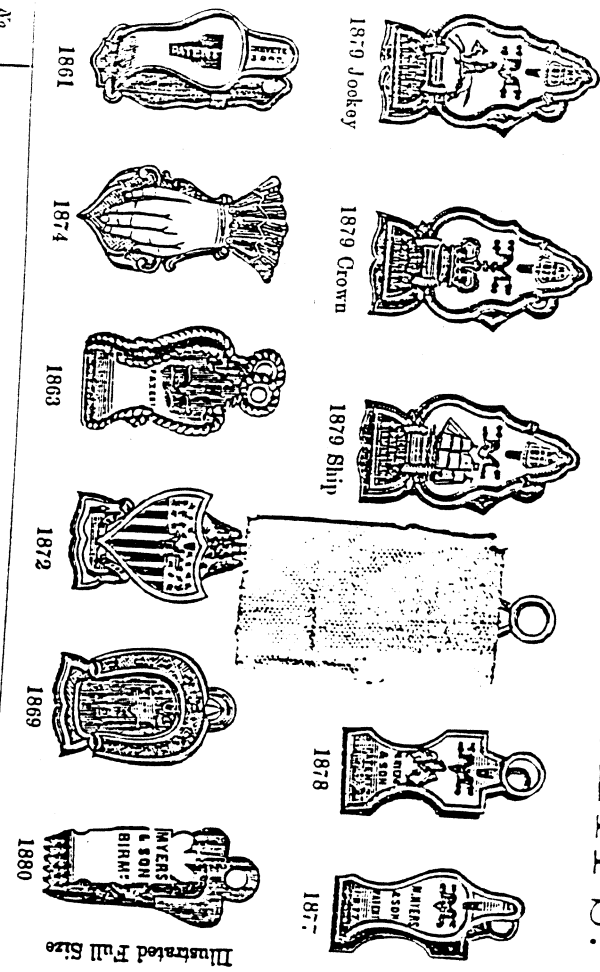

Illustrated Full Size

No.	Description	Per Doz.
1861	Patent Flat Steel Springs ..	32/-
1863	" "	32/-
1869	" "	32/-
1870	" Horse shoe pattern ..	32/-
1871	" "	32/-
1871	" " large size	32/-
1872	" " "	96/-
1872	" " American Eagle ..	24/-
1873	" " "	32/-
1874	" " " large size	32/-
1875	" " "	96/-
1876	" " "	32/-
1877	" " " large size	32/-
1878	" " "	48/-
1879	" " "	96/-
1880	" " " hip ..	24/-
1881	" " "	8/-
1875	" Nickel, Patent IP ..	24/-
1876	" " "	48/-
1876	" " "	48/-
1876	" " "	48/-
1876	" " "	96/-

Charlotte Street Steel Pen Works, Birmingham

PATENT TICKET FASTENERS AND VALENTINE HOOKS

For suspending Cards in Shop Windows, and for various other purposes.

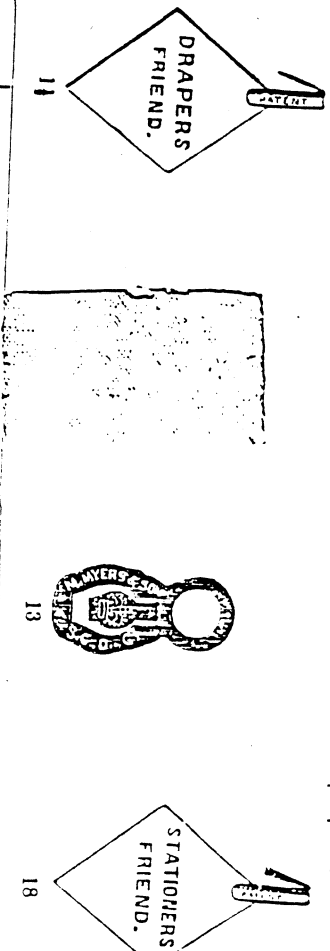

No.	Description	Per Doz.
18	Stationer's Friend, steel	1/-
18	" " " gilt	2/-
11	Draper's Friend, steel	1/-
11	" " " gilt	1/-
11	" " " steel, large size	2/-
13	" " " gilt	1/4
13	Flat Suspenders, steel, for cards, porcelain plates, &c.	2/4
2	" " " gilt	3/4
20	Valentine and Carte-de-Visite Hooks, steel	1/3
20	" " " gilt	2/-
20	Small Steel Clip, for holding papers	3/3
20	" " " gilt	4/-

ALMANACK SUSPENDERS

BRASS, OR SILVERED.

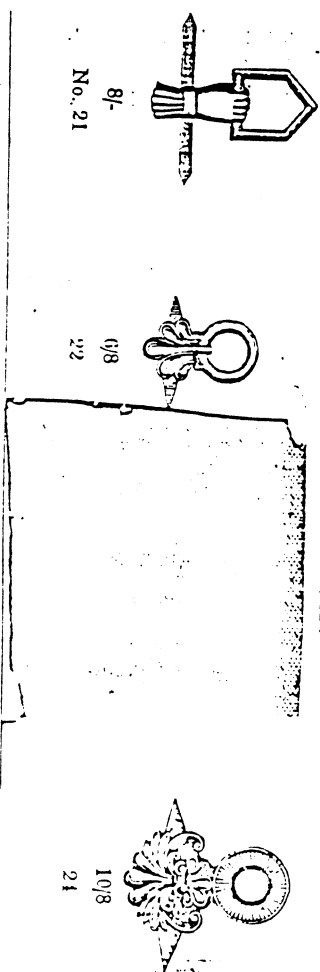

1 Charlotte Street Steel Pen Works, Birmingham.

No.	Description	Per Doz.
8/-	" "	9/8
21	" "	22
21	" "	19/8
21	" "	21

M. MYERS & SON'S

JEWELLERS' PATENT TICKET HOOKS.

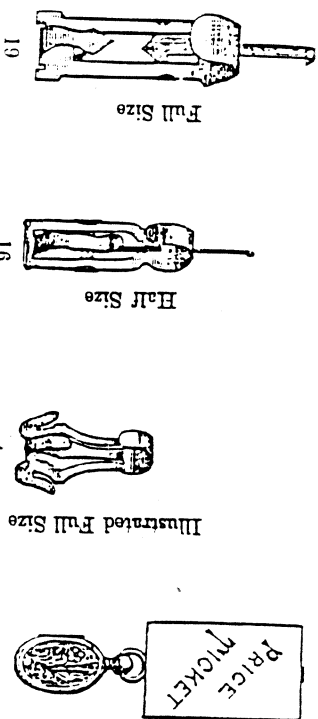

No.	Chain and Locket Hook, steel	Per Gro.
1	Gilt	4/8
1	Watch and Locket Hook, steel, small	6/8
1	Gilt	8/-
1	" " " " steel, large	10/8
1	Gilt	8/-
1	" " " " "	8/-
1	" " " " "	13/1

BRASS TABS FOR JEWELLERS.



No.	Oral	Per Gro.
1	Square	8d.
2	"	8d.

PASTE AND GUM BRUSHES

No.	Superior Quality Round Brush, on cards of 1 dozen	Per Gro.
1	Ditto	6/8
1	Ditto	6/7
2	Ditto	13/4
2A	Ditto	12/8

Charlotte Street Steel Pen Works, Birmingham.

PATENT BOOK MARKERS.



No.	Small Steel Bookmarker	Per Gro.
87	Ditto Gilt	8/-
86	Plate Indicators, gilt	12/-
32	Bookmarker and Paper Knife, Gilt, gilt	6/8
20	" " " " Ivory Blade, gilt mounts	8/-
20B	" " " " Ivory Blade, black	37/1
20S	" " " " Tortoiseshell Blade, gilt mounts	37/1
21	" " " " Ivory	37/1
25	" " " " Turtan Wood	49/-
28	" " " " "	49/-
	" " " " large size	6/8

PATENT KEY CHAINS, WITH KEYS ATTACHED FOR OPENING THE SNAPS.

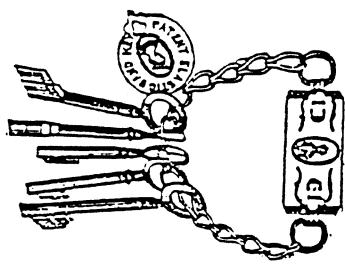

No.	Steel Chain, gilt snap	Per Gro.
1	"	16/-
2	"	24/-

PYRAMID SEAL.

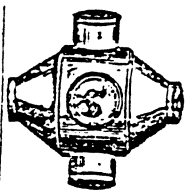

No. 1301—Nickel-plated Seal, with six different designs

Charlotte Street Steel Pen Works, Birmingham.

PATENT LEAD PENCIL POINT PROTECTOR



To those people who still prefer the Cedar Pencil these Point Protectors will be found of use, and also the artist, who will be enabled by their use to keep unbroken the finest point of his pencil. Easily removed.

No.	Description	Per Dozen	Per Gross
0	Richly Gilt, for small pencils, on cards of 3 dozen	..	8/-
1	Ditto " medium "	..	8/-
2	Ditto " large "	..	8/-
3	Bronze " "	..	9/4
4	Ditto, in boxes of 1 gross	2/6
	Silvered, with India Rubber, on cards of 3 dozen	4/-

LEAD PENCIL, POINT PROTECTOR & ERASER

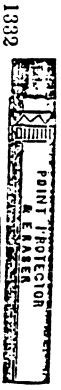

1333

222	Bronzed Point Protector, with rubber and superior cedar pencil, on cards of 3 dozen.	8/-
1332	Gilt " "	16/-
1332 1/2	Nickelized " "	16/-
1333	Ditto " "	16/-
	" " with propelling and repelling eraser	24/-

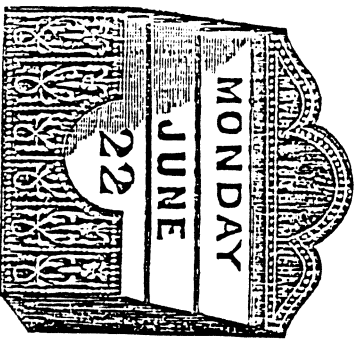

THE PERPETUAL DATE CASE

No. 1329—In English, French, or German, on Cards of 1 dozen 32/-

Charlotte Street Steel Pen Works, Birmingham.

M. MYERS & SON'S

SUPERIOR QUALITY PATENT PAPER BINDERS

(For Description, &c., see Page 39.)

304	31	31 1/2	32	32 1/2	33	34	35	36	37
-----	----	--------	----	--------	----	----	----	----	----

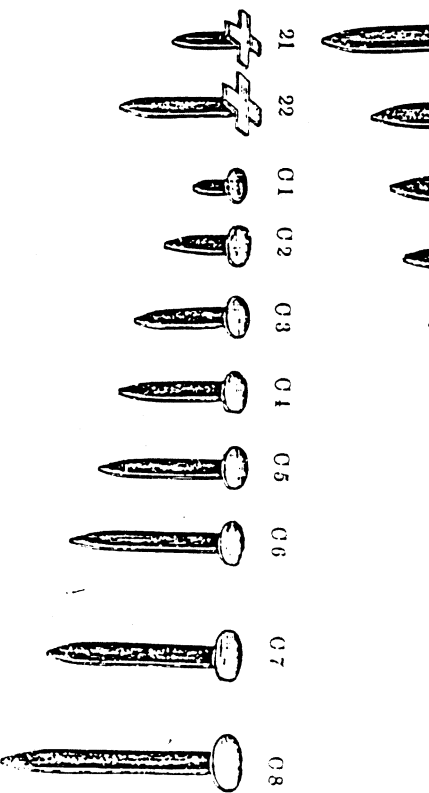
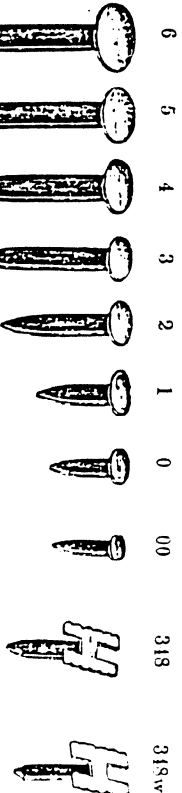
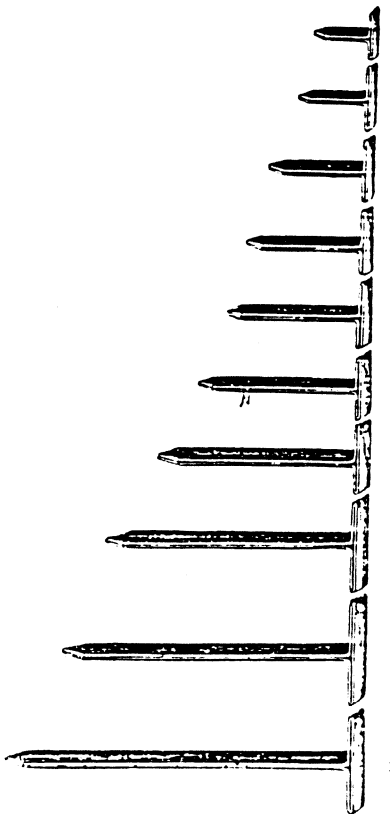

Charlotte Street Steel Pen Works, Birmingham.

M. MYERS & SON'S SUPERIOR QUALITY PATENT PAPER BINDERS

(For Illustrations, see Page 38)

1 Heads, silver-plated	5/-	5/8	6/8	8/-	9/8	13/-	17/8	25/-	30/-	36/-	per gross
	30/1	31	31 1/2	32	32 1/2	33	31	35	36	37	(12 gross)
10 Heads, silver-plated	7/1	9/-	9/8								
	21	22	318W.								
Ditto brass	9/-										
	318										
101 Heads, brass	5/-	5/8	6/-	4/8	10/8	12/6	14/8	19/8			
	00	0	1	2	3	4	5	6			
Ditto brass, light series	5/1	5/8	6/8	8/-	9/1	10/8	12/8	15/-			
	C.1	C.2	C.3	C.4	C.5	C.6	C.7	C.8			
101 Heads, nickel-plated	5/1	5/8	6/8	8/-	9/1	10/8	12/8	15/-			
	W.1	W.2	W.3	W.4	W.5	W.6	W.7	W.8			
Myers & Son's Patent	12/-	12/-									
	M.1	M.2									

BEST CUMBERLAND LEADS,
IN METAL BOXES, suitable for all Propelling and Repelling Pencils.



Round, coloured tin boxes, containing three 2-in. leads	6/8	Per Doz.
Flat, brass boxes, small size	6/8	Per Doz.
Ditto " large	9/8	Per Doz.
Ditto, fancy brass boxes, large size	2/4-	Per Doz.

METALLIC RULERS



No. 4	7-in. Polished Brass Ruler, lacquered	48/-	Per Doz.
6	9-in. Nickel-plated Ruler, with Penholder, Pencil and Eraser	96/-	Per Doz.
10	9-in. Black Enamelled Ruler, with Penholder, Pencil and Eraser	96/-	Per Doz.

On Cards of 1 dozen.

Charlotte Street Steel Pen Works, Birmingham.

THE HOUSEHOLD PAPER PIERCER

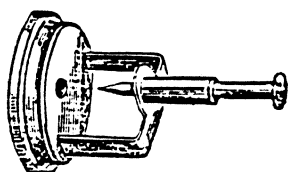

The Illustration represents a contrivance for piercing holes in a number of Invoices, or pieces of paper to facilitate the insertion of paper fastener or string.

The article is made of bronzed metal, and will be found very useful for domestic as well as office use.

Carried in 1/2 dozens. 8/- per dozen.

1338

THE SPECIAL PEN BOXES



248

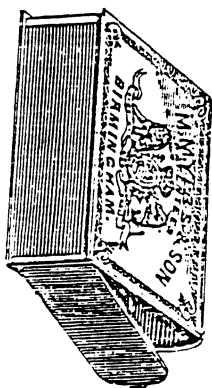

1878

No. 248	Handsome Marbled Box, assorted colours, with hinged lid, containing 1/2-gross best quality steel pens. One dozen boxes on card	96/-	Per Doz.
1878A	Handsome Metal Book Box, containing four dozen good steel pens, assorted	96/-	Per Doz.
1878	Ditto " with one gross pens, No. 3086	13/4	Per Doz.

WHIST MARKERS.

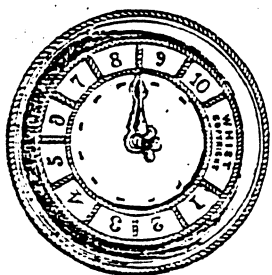

No. 1—Small Round Brass Whist Marker. One doz. on card.
No. 2—The Sentinel Whist Marker. One pair in box.

Per Doz. 19/-
Per Doz. 12/-

Charlotte Street Steel Pen Works, Birmingham.

POCKET LAMPS.
(ILLUSTRATED 1-SIZE)

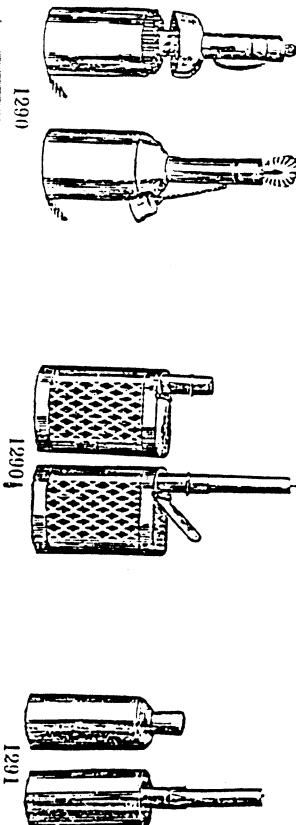

No.	Description	Per Doz.
1290	Nickel-plated Pocket Lamp, spring action, with Match Box combined	96/-
1290 1/2	Ditto Pocket Lamp and Match Box	96/-
1291	Ditto " small, round	48/-
Boxes of Candles suitable for these Lamps		Per Doz. 48/-

NEW POCKET LAMP

(ILLUSTRATED 1-SIZE)

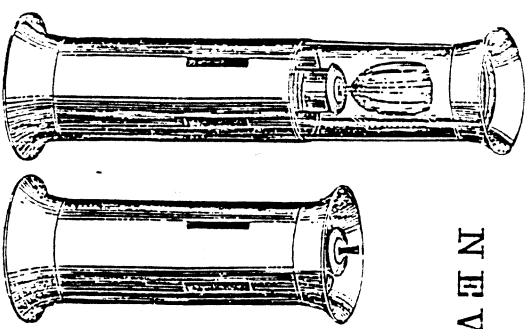

No. 250.—Brass Pocket Lamp, spring action, with telescopic glass shade, *quite new*, 96/- per gross.

NICKEL-PLATED PAPER KNIVES.

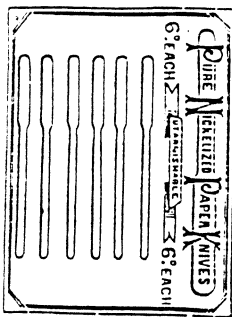

No. 1298—Nickel-plated Paper Knife. On cards of 1 doz. Per Gro. 48/-

THE EUREKA CANDLE LAMP.

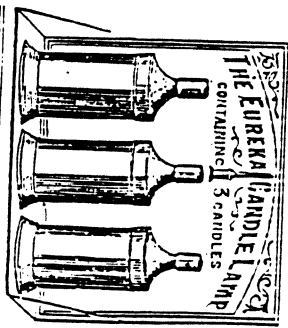

No. 1295—Brass Box and Lamp, containing three Wax Candles. Useful for the Office Desk. Per Gro. 90/-

INKSTANDS.

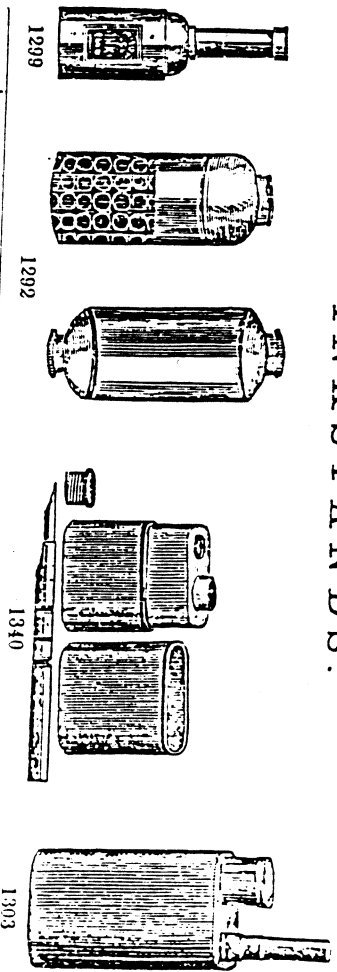

No.	Description	Per Gro.
1299	Brass Pocket Inkstand, containing Ink Pellets, with which good Ink can be made by adding clear water	96/-
1299	Brass Perpetual Ink Bottle, containing Solid Ink. A supply of good Ink can always be obtained from this bottle by adding clear water	96/-
1303	Nickel-plated Collector's Pocket Inkstand, flat, with Telescopic Penholder. Glass Ink Bottle	96/-
1303 1/2	Ditto " round	96/-
1340	The Commercial Pocket Inkstand, in Leather Case, with Telescopic Penholder	96/-
Try useful for Commercial Travellers, Collectors, &c		96/-

PENCILS, WITH MAGNIFIERS



No. 670—A very handy little article, made in Metal, Bone and Aluminium.

No.	Description	Per Gro.
721	Fixed Point, Metal, Electro-plated	48/-
670	Sliding Point, Bone	96/-
640	Spiral Point, Aluminium	114/-

Charlton Street Steel Pen Works, Birmingham.

PENHOLDERS, WITH INKSTANDS COMBINED

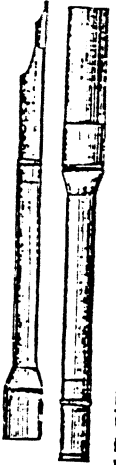
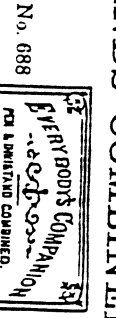
No 201		No. 688	
Everybody's Companion, Nickel-plated Penholder and Inkstand. On cards of 1 dozen		Per Doz	48/-
The Lilliputian Penholder and Inkstand, with Glass Ink Bottle		Per Doz	48/-

NEW PATENT MARVELLOUS PEARLS

(PATENTED IN FRANCE AND ABROAD)
THE WRITER WITHOUT INK WITH ALL KINDS OF PENS.



Take a pearl with the paper adhering to it. If the weather is dry soften the same by breathing upon it, or by holding it to a mild heat for a few seconds; then press it into the cavity of the pen. Remove the paper and steep the pen in water if you wish to write. One pearl is sufficient for one month. A large pen will hold two pearls. May be had to make RED, BLACK, or VIOLET INK.
 Boxes containing Twenty Rolls of Pearls, 3/4 per Box.

MATCH AND FUSEE BOXES

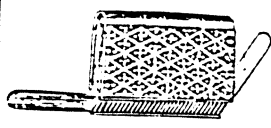
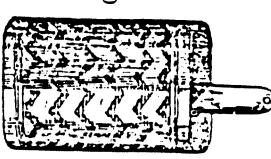
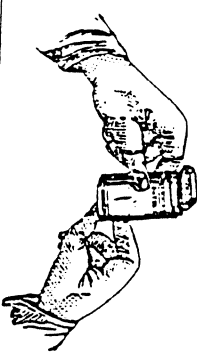
1314		10		
------	--	----	---	---

No	The Patent Magic Match Box, Silver-plated, superior finish	Per Doz.	16/-
0	Nickel-plated, Patent Slide, Match Box	..	12/-
2	Ditto Hinged Lid	..	4/4
10	Gilt, Book Shape, Match Box	..	4/-
1314	Nickel-plated	Leather centre	8/-

Charlotte Street Steel Pen Works, Birmingham

A NEW ROUND GAME

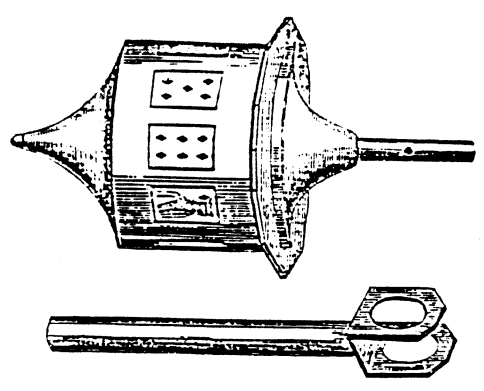

MONACO, OR PARLOUR LOTTERY

This novel and interesting Game is an endless source of amusement to old and young. It is, without doubt, the most perfect Round Game ever invented, and will we feel convinced, be a constant fund of enjoyment through the long Winter evenings; the excitement never flagging for a moment, and as any number of persons can conveniently play at the same time, the Monaco or Parlour Lottery cannot fail to be universally appreciated. We present a sheet of instructions for the Game with each Monaco.

Separately Boxed, 96/- per gross.

THE PENTIDOSCOPE.

The various changes of form and colour which may be seen with this article will be found very interesting to persons fond of studying the blending of colours.

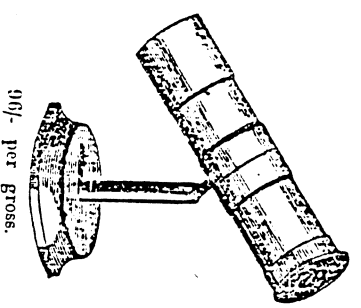

The Pentidoscope may either rest on the Table or can be held up to the eye, when by slightly twisting the tube round, the various formations may readily be seen.

96/- per gross.

Charlotte Street Steel Pen Works, Birmingham.

THE COMPANIONS

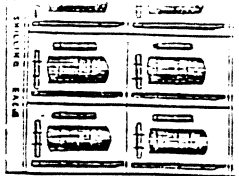

POCKET COMPANIONS.

No. 8—Brass Pocket Companion, consisting of Bottle of Ink, Pencil, Penholder, Box of Pens, and Box of Leads. Six sets on a card 96/-

Per Gro.

THE SCHOOL BOARD PEN.

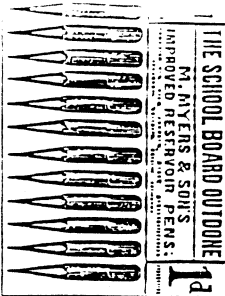

No. 3181—School Board Pen. The most perfect Reservoir Pen in the market. The very large sale this Pen commands is the best proof of its quality. On cards of 1 dozen 8/-

Per Gro.

CIGAR CUTTERS AND BOXES

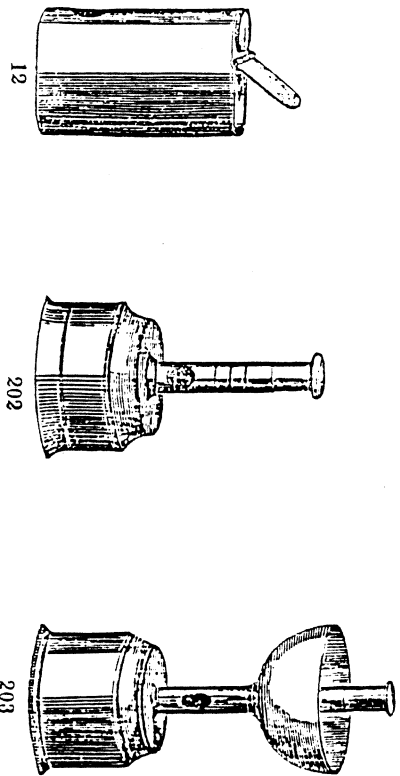

No. 12	Nickel-plated Cigar Cutter and Box	Per Doz.
202	" with Ash Tray ..	12/-
203	" and Match Box for the Pocket ..	21/6
12	" ..	8/-

Charlotte Street Steel Pen Works, Birmingham.

PATENT TELESCOPIC CIGAR CUTTERS.

No. 11	Steel, black ..	Per Doz.
1	Ditto, gilt ..	20/-
2	G. Silver Nickelized ..	32/-
	" ..	49/-

CIGAR CUTTER PENCILS

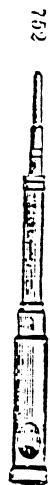

750 | Nickel-plated Cigar Cutter, with Pen and Pencil combined Per Doz. 8/-

SMOKERS' COMPANION.

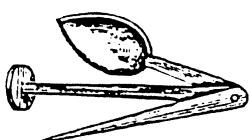

German-silver. On cards of 1 dozen 10/- per Gross

FLORAL SYRINGES.



No. 1297	Brass Syringe, 8 1/2 inches long, with Screw Lock and Rose ..	Per Doz.
1297A	Nickelized " ..	8/-
1297B	" ..	8/-
	" with extra fine holes ..	8/-

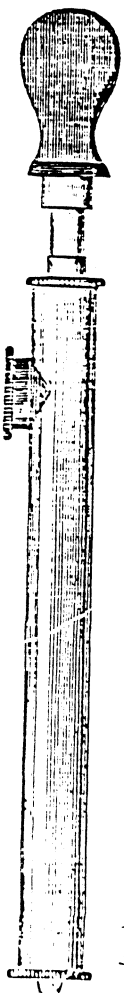

1341 | Brass Syringe, 9 inches long, with Rose and Jet 20/-

Charlotte Street Steel Pen Works, Birmingham.

CARDED PENS.

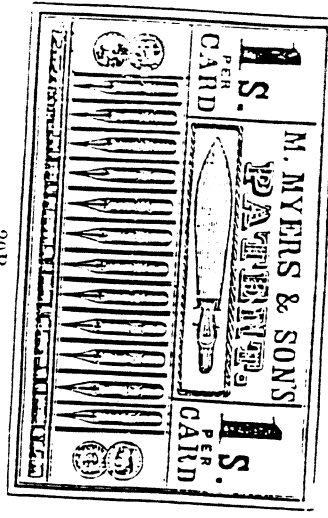

20P

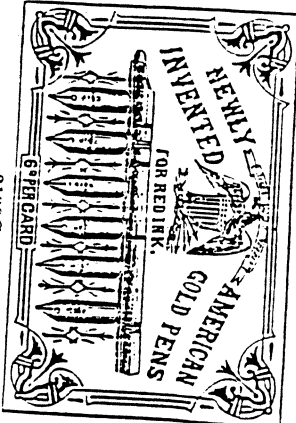

31990

No.	Description	Per Doz.
0310	One doz. Best Gilt Pens and Tartan Holder with gilt tip, on card	48/-
31990	Half doz. American Gold Pens and German-silver Holder	48/-
	Mullum-in-Larvo Card, containing twelve good Pens, Penholder, India Rubber, Gilt Indicator, Keypenke, and Cedar Pencil	48/-
20P	One doz. Best Gilt Pens and Tartan Holder, gilt tip, with Ivory Paper Knife	96/-
20SP	One doz. " " " " with Tortoiseshell " "	90/-
25P	One doz. " " " " Tartan " "	90/-

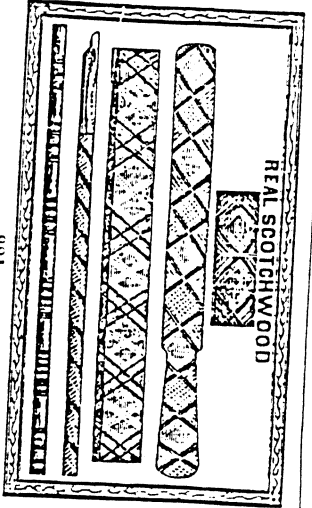

821

No.	Description	Per Doz.
820	Card, containing Penholder, Pencil, Flat Ruler, and Paper Knife; Scotch Tartan	54/-
819	Card, containing Penholder, Pencil, Flat Ruler, Paper Knife & Pen Box; Scotch Tartan	68/-
822	Card, containing Penholder, Pencil, Flat Ruler, Paper Knife, Pen Box, and Penknife	116/-
823	Card, containing Penholder, Pencil, Flat Ruler, and Paper Knife; Coloured Flowers	57/-
825	Card, containing Penholder, Pencil, 9-inch Flat Ruler, 9-inch Paper Knife, Pen Box, Penknife, and Pink India Rubber; Scotch Tartan	72/-
903	Card, containing 9-inch Paper Knife, 9-inch Flat Ruler, Date Case, and Inkstand	21/4

Charlotte Street Steel Pen Works, Birmingham.

WRITING MATERIALS

SCOTCH TARTAN GOODS

MANUFACTURED BY M. MYERS & SON.



106

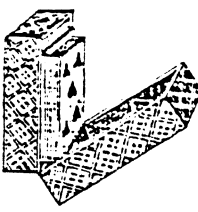

198



162

No.	Description	Per dozen	No.	Description	Per dozen
178	Ash Cup	10 8	281	Date Box, English	11 8
312	Ash Tub	8 0	425	Ditto French	11 8
802	Assorted Articles, 12 on a Card, 6d. each, por doz Cards	48 0	426	Ditto German	11 8
800	Ditto " " 12 " 6d. " "	72 0	361	Date and Stamp Box	21 0
800	Ditto " " 18 " 1/- " "	96 0	98	Emory " "	3 4
348	Band Box	7 6	427	Egg Box, small	3 4
189	Berlique Markers, small	7 4	428	Ditto 3 in.	3 4
197	Ditto " "	8 0	292	Egg Holder	6 0
396	Berlique Box	40 0	90	Egg Cup	7 4
25	Book Marker, patent spring clip	4 0	429	Eggs, assorted	4 0
28	Ditto " "	5 6	389	Eraser, flat	7 4
111	Bookin Case, large	3 4	14	Fruit Knife, small	7 4
96	Crochet " round	10 8	88	Frisson Box, oval slide, medium	8 8
208	Ditto " oval	13 0	413	Ditto " "	8 8
209	Ditto " hexagon	13 0	265	Ditto " "	8 8
125	Card Case, Clente, pull off	15 0	293	Glove Strideler, small	7 4
414	Ditto " "	16 4	287	Ditto " "	11 0
415	Ditto " "	14 6	291	Ditto " "	13 0
215	borehole edge " "	18 8	169	Hair Pin Box, round	7 4
296	Ditto " " pull off	20 0	282	Ditto " " with drawer	12 0
406	Ditto " " pull off	18 0	160	Inkstand, small round	8 8
279	borehole edge " " hinged	18 6	205	India beehive	22 0
260	Card Box, 1 puck English Cards, borehole edge " "	20 0	99	India Rubber	4 0
270	Ditto 2 " French " "	18 8	165	Ditto	4 0
417	Ditto 2 " " " "	25 0	292	Match Box, small round	4 0
161	Ditto 2 " " " "	33 4	137	Match Box, medium	5 4
183	Ditto 1 " " " "	33 4	206	Mirror, pocket	5 4
353	Ditto 2 " " " "	36 0	173	Match Box, oval, small	7 4
214	Count Planer, small	8 0	138	Ditto " " medium	6 8
244	Ditto large	10 8	172	Ditto " " hinged	12 0
162	Gilbrow Board, large	14 0	227	Ditto " "	6 3
383	Ditto " " small	8 0	358	Ditto " " bull, small	8 8
198	Ditto Box, with Berlique markers	32 0	135	Ditto " " large	13 4
424	Ditto " "	29 4	402	Ditto " " drum	10 0
			148	Ditto " " cannon	18 0

Charlotte Street Steel Pen Works, Birmingham

SCOTCH TARTAN GOODS—(Continued)

No.	Description	Per dozen.	No.	Description	Per dozen.
430	Measure Spring, English	8 0	291	Ice-crem, bottle shape, small	8 0
106	Metallic Book, small	11 4	312	Ditto	6 0
107	Ditto	14 0	350	Ditto	8 0
108	Ditto	18 0	395	Ditto	4 0
174	Needle Case, bevelled	10 0	391	Ditto egg and cup, small	7 0
92	Ditto	10 0	324	Photo Frame, Oxford	8 8
225	Ditto	12 0	383	Ditto	8 0
153	Needle Hook, small	12 0	258	Photo Frame, Oxford	16 0
150	Ditto	6 4	267	Photo Box, 2 1/2 in.	9 4
151	Ditto	8 0	259	Ditto	12 0
152	Ditto	13 0	431	Ditto	16 0
411	Ditto	12 0	432	Ditto	11 4
147	Necktie Rings, small	16 0	433	Ditto	14 0
238	Ditto	2 4	129	Pin cushion, round, small	18 0
103	Paper Knife, small	2 10	177	Ditto	3 4
102	Ditto	6 6	128	Ditto	4 4
101	Ditto	8 0	220	Ditto	4 4
104	Ditto	10 8	219	Ditto	5 4
112	Ditto	5 6	218	Ditto	5 4
113	Ditto	6 8	222	Ditto	3 4
300	Ditto	8 0	217	Ditto	7 0
405	Ditto	4 0	216	Ditto	4 0
375	Ditto	4 0	182	Ditto	8 0
303	Ditto	9 0	272	Ditto	12 0
362	Ditto	9 0	261	Ditto	12 0
338	Ditto	8 8	302	Ditto	12 0
368	Ditto	10 8	408	Ditto	7 6
624	Penknives, small toy	18 6	201	Ditto	3 4
3	Ditto	4 0	126	Ditto	8 0
10	Ditto	7 4	225	Ditto	10 0
12	Ditto	12 0	127	Ditto	10 0
13	Ditto	16 8	351	Pocket Comb and Case	12 0
403	Pen Tray, plain round	18 8	434	Reel box, for 3 reels	6 8
121	Ditto	4 0	290	Ditto	9 4
120	Ditto	8 0	115	Ditto	14 0
201	Ditto	8 0	349	Ditto	18 8
168	Pen Box, small	12 0	385	Ditto	12 0
247	Ditto	13 4	384	Ditto	17 6
132	Penknives	18 8	298	Ruler, round solid, 6 in.	25 0
109	Pen Tray	8 8	331	Ditto	4 0
281	Ditto	16 0	110	Ditto	8 0
130	Pen Brush	13 4	110	Ditto	7 0
S10	Pen Box, round, for 1 doz. pens	1 3	110	Ditto	10 in.
S2	Ditto	1 8	240	Ditto	12 in.
S3	Ditto	2 2	240	Ditto	11 0
S4	Ditto	2 0	240	Ditto	7 0
S1	Ditto	2 8	367	Ditto	8 0
S6	Ditto	8 0	196	Ditto	10 0
S5	Ditto	12 0	196	Ditto	4 0
S8	Ditto	9 4	196	Ditto	7 0
156	Ice Nic, egg shape, small	8 0	143	Ditto	8 0
310	Ditto	6 0	143	Ditto	10 0
		8 0	370	Ditto	4 0
		0 0			10 0

Charlotte Street Steel Pen Works, Birmingham.

SCOTCH TARTAN GOODS—(Continued)

No.	Description	Per dozen.	No.	Description	Per dozen.
86	Stamp Box, 3 divisions	12 0	326	Thumb Case, bevelled	7 4
372	Ditto	14 0	94	Thermometer, flat	15 0
236	Scissor, Slonithy, small	3 4	420	Ditto	29 0
237	Ditto	4 0	283	Ditto	21 0
230	Silk Winder, cross	3 4	315	Top, French	15 0
89	Ditto	3 4	421	Trunk	15 0
228	Ditto	3 4	194	Trunk	8 0
100	Spectacle Case, 6 in.	15 0	212	Vinagreto Box	17 0
418	Ditto	16 0	116	Watch Stand	13 4
179	Ditto	8 0	180	Watch	16 0
301	Tablet	8 0	180	Watch	3 4
235	Tattooing Shuttle	2 0	422	Wool Box, large	32 0
297	Teetobum	3 4	356	Ditto	15 0
163	Toothpowder Box, small	6 0	339	Ditto	15 0
164	Ditto	6 0	423	Ditto	21 0
419	Thumb Case, bevelled	8 0	207	Waxer	16 0
179	Ditto	7 4	142	Waxer	3 4
			313	Ditto	3 4

Terms:

Discount:

Charlotte Street Steel Pen Works, Birmingham.

M. MEYERS, SON, PATENTEES AND MANUFACTURERS

SCOTCH TARTAN GOODS—(Continued)

No.	Description	For dozen	No.	Description	For dozen
86	Stamp Box, 3 1/2 in. high	12 0	326	Thimble Case, beehive	7 0
372	Ditto, 4 1/2 in. high	14 0	91	Thermometer, flat	16 0
235	Stitcher, small	3 4	420	Ditto, obelisk, small	20 0
237	Ditto, large	4 0	283	Ditto, large	24 0
230	Silk Winder, gross	3 4	315	Tops, French	18 0
89	Ditto, pair	3 4	421	Twine box	18 0
229	Ditto, pair	3 4	194	Trunk	17 0
100	Specimen Case, 6 in. diam	15 0	212	Vanigrette box	13 4
418	Ditto, 6 1/2 in. diam	16 0	116	Watch Stand	16 0
179	Tablet	8 0	180	Whistle	3 4
801	Tablet	8 0	222	Wool Box, large	32 0
235	Tasting Shuttle	2 0	866	Ditto, tub shape	16 0
297	Teetum	3 4	839	Ditto, ball	21 0
163	Teetum	7 0	423	Ditto, round	16 0
161	Ditto, large	7 0	207	Waxer	3 4
119	Thimble Case, hinged	8 0	142	Wooler box	3 4
179	Ditto, barrel	7 4	313	Ditto, hollow edge	3 4

Terms:

Discount:

IVOK STILITZ
23 ROOKFIELD AV.
LONDON N10 3TS

(Charlotte Street Steel Pen Works, Birmingham)